

# SEAFOOD CATALOG

800-456-5624 • [bunzlprocessor.com](http://bunzlprocessor.com)

2025



®

Processor Division

**KOCH** SUPPLIES

# Bunzl Processor Division . . . Over 140 Years of the Right People, Right Products and Right Prices



Bunzl Processor Division is a leading supplier of the food processing industry. The acquisition of Koch Supplies, Packers Engineering & Equipment and Enterprise allowed us to combine and expand our product offerings, warehousing, distribution expertise and buying power – giving our customers a high level of quality and service. We provide

an unparalleled ability to service national platforms; as well as multi-plant, single-plant, small shops and game processors.

## A Renowned History

Koch Supplies is one of the oldest businesses in Kansas City, establishing its roots as Koch Butcher Supply Company over 140 years ago. In fact, the grandchildren of people who did business with Koch Supplies during the World War II era are now running many of their family's businesses and are some of our best customers. Many of the associates at Bunzl Processor Division/Koch Supplies have tenure of over 20 years, with their relatives and children working alongside them.



In 2001, Koch Supplies became a proud part of Bunzl Processor Division – a leader in the food processing and food packaging industries. Bunzl Processor Division offers more than 35,000 different supply items and 14 distribution centers serving Central and North America, including the Caribbean







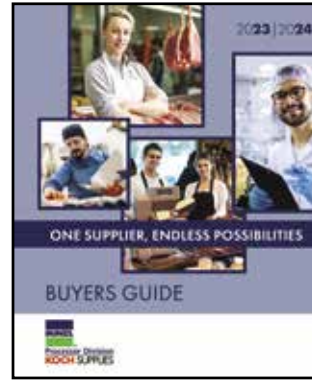



and Mexico. But even though we have grown in size and scope, we continue the tradition of outstanding customer service that our customers have come to expect of us over the years, while ever expanding our product lines to fit our customers' needs.

## Why Buy From Bunzl Processor Division?

- Dedicated exclusively to food processors
- 14 distribution centers
- Award-winning service
- Inside and outside sales and support
- Over 140 years in the industry
- Free UPS ground shipping on orders over \$500
- Small orders – no problem
- Large orders – big savings



*This is just a sampling of our plant operating supplies. Call 800-456-5624 or go to [bunzlprocessor.com](http://bunzlprocessor.com) to order your copy of our Buyers Guide catalog.*

	CLOTHING .....	3-16
	JAN/SAN.....	17-20
	MATERIAL HANDLING.....	21-25
	SAFETY.....	26-30
	FURTHER PROCESSING.....	30
	CUTLERY .....	31-34
	BLADES .....	34-36
	PROCESSING .....	36
	PACKAGING .....	37-38
	SCALES .....	39



**WARNING:** Some products in this catalog may expose you to chemicals including DEHP Di (2-ethylhexyl) phthalate or BPA (Bisphenol A) which are known to the State of California to cause cancer or birth defects or other reproductive harm. For more information, visit [www.P65Warnings.ca.gov](http://www.P65Warnings.ca.gov).

# Nitrile Disposable Gloves

Protection against animal fats, oil-based solvents, petroleum and caustics with strength, puncture-resistance and color-coding compliance.

- Fingertip texture improves grip without sacrificing dexterity.
- 5 mil at the palm. • 9" glove length. • Ambidextrous. • Powder-free



**650** SERIES

**LATEX FREE**

CLOTHING

## Black

ITEM NO.	SIZE
E542 02755	Small
E542 02765	Medium
E542 02775	Large
E542 02785	X-Large
E542 02795	2X-Large

## Orange

ITEM NO.	SIZE
E542 02555	Small
E542 02565	Medium
E542 02575	Large
E542 02585	X-Large
E542 02595	2X-Large

## Lime Green

ITEM NO.	SIZE
E542 02655	Small
E542 02665	Medium
E542 02675	Large
E542 02685	X-Large
E542 02695	2X-Large

## Green

ITEM NO.	SIZE
E542 04215	Small
E542 04225	Medium
E542 04235	Large
E542 04245	X-Large
E542 04255	2X-Large

## Grape

ITEM NO.	SIZE
E542 02455	Small
E542 02465	Medium
E542 02475	Large
E542 02485	X-Large
E542 02495	2X-Large

## Blue

ITEM NO.	SIZE
E542 04115	Small
E542 04125	Medium
E542 04135	Large
E542 04145	X-Large
E542 04155	2X-Large



**THE BENCHMARK  
IN DISPOSABLE NITRILE GLOVES**

▶ 100 PER BOX -  
10 BOXES PER CASE -  
50 CASES/PALLET

**BOX**  
**\$13.51**

**450** SERIES

- 3.5 mil at the palm.

## Blue

Powder-Free

ITEM NO.	SIZE
E542 04265	Small
E542 04275	Medium
E542 04285	Large
E542 04295	X-Large
E542 04305	2X-Large

▶ 100 PER BOX -  
10 BOXES PER CASE -  
50 CASES/PALLET

**BOX**  
**\$11.20**



## Shoulder-Length, Poly Disposable Gloves

- Made of 1.5 mil poly film. • Ambidextrous.
- Length: 34 inches. • Color: white.



▶ 100 PER BOX - 10 BOXES PER CASE.

ITEM NO.	SIZE	BOX
3439 04885	One Size Fits All	<b>\$14.95</b>

PRICES ARE SUBJECT TO CHANGE • MINIMUMS MAY APPLY • VISIT OUR WEBSITE FOR CURRENT PRICING.



## Knit Gloves

- Poly/cotton blend knitted gloves.
- Bleached and unbleached with sewn wrist bands.
- Color-coded cuff edges designates glove weight.
- Ambidextrous and machine washable.
- One Size Fits All.



**22 GRAMS**

**28 GRAMS**

### Light-Weight Knit Gloves

Natural with white cuff edge.

▶ 12 PAIR PER PACK - 40 PACKS PER CASE.

ITEM NO.	PRODUCT	PACK
E542 03725	Light-Weight Glove .....	<b>\$7.01</b>

### Medium-Weight Knit Gloves

White with green cuff edge.

▶ 12 PAIR PER PACK - 40 PACKS PER CASE.

ITEM NO.	PRODUCT	PACK
E542 03745	Medium-Weight Glove.....	<b>\$10.16</b>

## North<sup>®</sup> Nitri-Knit<sup>™</sup> Insulated Supported Nitrile Coated Gloves



High performance supported nitrile gloves, excellent protection against solvents, caustics and animal fats.

- Complies with USDA and FDA regulations, 21 CFR, for use in food processing.
- Gloves will not swell, sag or weaken from fat absorption.
- Nitrile offers superior mechanical strength and outperforms supported natural rubber, neoprene and vinyl gloves when exposed to solvent, caustics and animal fats.
- True dip coated glove has a permanent bond of nitrile to inner-liner; won't peel apart like glued-in liners.
- Hand portion is treated with a permanent anti-bacterial and anti-mildew agent.
- Insulated versions recommended for temperatures from -10 °F to 300 °F (-23 °C to 149 °C).
- Pebble textured for added grip on wet or dry surfaces.



Pebbled grip finish.

12" Short Length

**PROTECTS DOWN TO**  
**|-10 °F|**

**NOTE: Order one size larger in this style of glove.**



26" Shoulder Length



Insulated gloves provide added protection for hot or cold applications. Recommended temperatures -10 °F to 300 °F.

### 12 Inch Short Length

ITEM NO.	SIZE
3476 83371	Size 7
3476 83381	Size 8
3476 83391	Size 9
3476 83401	Size 10
3476 83411	Size 11

▶ 6 PAIR PER CASE.

**PAIR**  
**\$19.76**

### 26 Inch Shoulder Length

ITEM NO.	SIZE
3476 80421	Size 7
3476 80431	Size 8
3476 80441	Size 9
3476 80451	Size 10
3476 80461	Size 11

▶ 6 PAIR PER CASE.

**PAIR**  
**\$49.57**

PRICES ARE SUBJECT TO CHANGE • MINIMUMS MAY APPLY • VISIT OUR WEBSITE FOR CURRENT PRICING.

# WorkHorse® 11 Mil Unlined, 13-Inch Straight Cuff Nitrile Gloves

- Chlorinated for ease of donning and doffing.
- Lint-free and reusable.
- Fingertip precision with high dexterity.
- FDA-compliant.

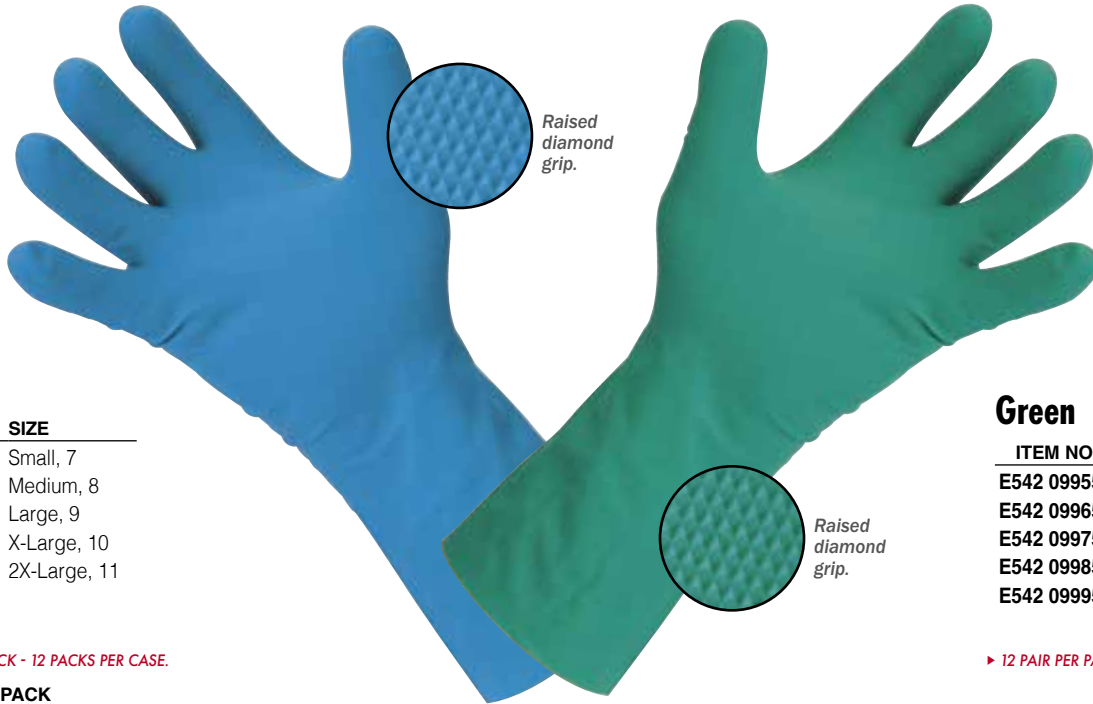

## Blue

ITEM NO.	SIZE
E542 10055	Small, 7
E542 10065	Medium, 8
E542 10075	Large, 9
E542 10085	X-Large, 10
E542 10095	2X-Large, 11

▶ 12 PAIR PER PACK - 12 PACKS PER CASE.

**PACK**  
**\$18.85**

## Green

ITEM NO.	SIZE
E542 09955	Small, 7
E542 09965	Medium, 8
E542 09975	Large, 9
E542 09985	X-Large, 10
E542 09995	2X-Large, 11

▶ 12 PAIR PER PACK - 12 PACKS PER CASE.

**PACK**  
**\$18.85**

# WorkHorse® 12-Inch, Blue Latex Reusable Gloves, 13 Mil

- Anatomically shaped for comfort.
- Beaded cuff to improve tear-resistance.
- Anti-slip honeycomb grip.
- Natural rubber.



Honeycomb grip.

ITEM NO.	SIZE
E542 11355	Size 7
E542 11365	Size 8
E542 11375	Size 9
E542 11385	Size 10
E542 11395	Size 11

▶ 12 PAIR PER PACK - 12 PACKS PER CASE.

**PACK**  
**\$12.96**

PRICES ARE SUBJECT TO CHANGE • MINIMUMS MAY APPLY • VISIT OUR WEBSITE FOR CURRENT PRICING.

# Iron Eagle® Polyurethane-Coated Nylon Rainsuit

5.5 ounce material weight, 10 mil thick.

- 2 mil exterior polyurethane coating on 200 denier nylon oxford fabric is resistant to abrasions, fats, oils, pine tars, gasoline, grease and a variety of other liquids and chemicals.
- Light-weight/flexible material stays soft and comfortable in cold conditions.
- Slick coating sheds liquids with ease, making this suit easy to clean.
- Heavy-duty snaps are guaranteed not to corrode.
- Therm-O-Rad sealed seams are guaranteed for 100% liquid proof protection, and can withstand extensive laundering.
- Designed to withstand the demands of food processing and sanitation.

**TINGLEY**



Detachable hood.



Jacket with hood.



Full cut shoulder with 90° sleeve to body angle.

Heavy-duty snaps are guaranteed not to corrode.



Heavy-duty suspenders with crossover back.



## Jacket with Hood

				▶ 12 PER CASE.	
GOLD ITEM NO.	GREEN ITEM NO.	SIZE		EACH	
4059 21071	4059 2178	Small	.....	\$49.32	
4059 21081	4059 2179	Medium	.....	49.32	
4059 21091	4059 2180	Large	.....	49.32	
4059 21101	4059 2181	X-Large	.....	49.32	
4059 21111	4059 2182	2X-Large	.....	54.64	
4059 21121	4059 2183	3X-Large	.....	54.64	
4059 21131	4059 2184	4X-Large	.....	54.64	

Yellow jacket with hood also available in XS, 5X and 6X size. Call for more details.

## Jacket without Hood (includes Hood Snaps)

				▶ 12 PER CASE.	
GOLD ITEM NO.	GREEN ITEM NO.	BLUE ITEM NO.	SIZE	EACH	
4059 02071	4059 22281	4059 22001	Small	.....	\$41.25
4059 02081	4059 22291	4059 22011	Medium	.....	41.25
4059 02091	4059 22301	4059 22021	Large	.....	41.25
4059 02101	4059 22311	4059 22031	X-Large	.....	41.25
4059 02111	4059 22321	4059 22041	2X-Large	.....	45.60
4059 02121	4059 22331	4059 22051	3X-Large	.....	45.60
4059 02131	4059 22341	4059 22061	4X-Large	.....	45.60

## Hood with Snaps

				▶ 12 PER CASE.	
GOLD ITEM NO.	GREEN ITEM NO.	BLUE ITEM NO.	SIZE	EACH	
4059 2147	4059 2148	4059 21411	One Size	.....	\$12.95

## Overalls

				▶ 12 PER CASE.	
GOLD ITEM NO.	GREEN ITEM NO.	BLUE ITEM NO.	SIZE	EACH	
4059 20071	4059 23081	4059 73001	Small	.....	\$39.15
4059 20081	4059 23091	4059 73011	Medium	.....	39.15
4059 20091	4059 23101	4059 73021	Large	.....	39.15
4059 20101	4059 23111	4059 73031	X-Large	.....	39.15
4059 20111	4059 23121	4059 73041	2X-Large	.....	42.40
4059 20121	4059 23131	4059 73051	3X-Large	.....	42.40
4059 20131	4059 23141	4059 73061	4X-Large	.....	42.40

Yellow overalls also available in 5X and 6X size. Call for more details.

# 0.16 mm Impertech™ Sanitation Bib



Chemical and mildew resistant.

- 0.16 mm circular knit polyester backing with stretch polyurethane coating.
- High waist bib pant with elastic at ankles.
- Adjustable elastic suspenders.
- Chest pocket with hook and loop closure on right side.
- Snap adjustment at hem and waist.
- MicroWeld® seam construction.
- Blood borne pathogen tested — blood doesn't penetrate the garment.
- Color: navy.



▶ 10 PER CASE.

ITEM NO.	PRODUCT	EACH
6417 05901	X-Small	\$67.85
6417 05911	Small	67.85
6417 05921	Medium	67.85
6417 05931	Large	67.85
6417 05941	X-Large	67.85
6417 05951	2X-Large	67.85
6417 05961	3X-Large	69.56

# 0.16 mm Impertech™ Sanitation Jacket



Super tough yet comfortable to wear.

- 0.16 mm circular knit polyester backing with stretch polyurethane coating.
- Attached hood with elastic for added protection.
- Elastic on wrists for snug fit.
- Back cape for ventilation.
- MicroWeld® seam construction.
- Generously cut with raglan sleeves.
- Front zip with snap storm flap.
- Over flap front closure with plastic snaps.
- Blood borne pathogen tested.
- Color: navy.



▶ 10 PER CASE.

ITEM NO.	PRODUCT	EACH
6417 03171	X-Small	\$67.85
6417 03181	Small	67.85
6417 03191	Medium	67.85
6417 03201	Large	67.85
6417 03211	X-Large	67.85
6417 03221	2X-Large	67.85
6417 03231	3X-Large	69.56

# 0.35 mm Mandal Jacket

Chemical and mildew resistant.

- PVC on a durable polyester scrim backing.
- Drawcord hood.
- Storm flap with snap closure.
- Extreme weather protection.

YELLOW		ORANGE		WHITE		DARKGREEN		SIZE	EACH
ITEM NO.	ITEM NO.	ITEM NO.	ITEM NO.	ITEM NO.	ITEM NO.	ITEM NO.	ITEM NO.		
6417 02111	---	6417 25001	6417 14801	X-Small	\$47.16				
6417 02121	6417 02321	6417 25011	6417 14811	Small	47.16				
6417 02131	6417 02331	6417 25021	6417 14821	Medium	47.16				
6417 02141	6417 02341	6417 25031	6417 14831	Large	47.16				
6417 02151	6417 02351	6417 25041	6417 14841	X-Large	47.16				
6417 02161	6417 02361	6417 25051	6417 14851	2X-Large	47.16				
6417 02171	6417 02371	6417 25061	6417 14861	3X-Large	48.83				

▶ 10 PER CASE.

# 0.35 mm Mandal Bib

Chemical and mildew resistant.

- PVC on a durable polyester scrim backing.
- Symmetrical cut on front and back.
- Heavy-duty attached suspenders and click-type connectors.
- Take-up snap at waist.

YELLOW		ORANGE		WHITE		DARKGREEN		SIZE	EACH
ITEM NO.	ITEM NO.	ITEM NO.	ITEM NO.	ITEM NO.	ITEM NO.	ITEM NO.	ITEM NO.		
6417 13101	---	---	6417 04801	X-Small	\$47.16				
6417 13111	6417 13211	6417 13311	6417 04811	Small	47.16				
6417 13121	6417 13221	6417 13321	6417 04821	Medium	47.16				
6417 13131	6417 13231	6417 13331	6417 04831	Large	47.16				
6417 13141	6417 13241	6417 13341	6417 04841	X-Large	47.16				
6417 13151	6417 13251	6417 13351	6417 04851	2X-Large	47.16				
6417 13161	6417 13261	6417 13361	6417 04861	3X-Large	48.83				

▶ 10 PER CASE.



PRICES ARE SUBJECT TO CHANGE • MINIMUMS MAY APPLY • VISIT OUR WEBSITE FOR CURRENT PRICING.



### Neoprene Apron

- Neoprene coated twice on the front, this apron will not absorb water.
- Every edge is hemmed.
- Weight: 16 ounces.
- 45 inches L x 35 inches W.
- 36-inch sewn ties with metal grommets.



Sewn neck band does not adjust.

► 12 PER CASE.

ITEM NO.	COLOR	EACH
3279 35461	Maroon	\$18.80



### 16 Mil Hycar Apron

Offering the highest level of abrasion-resistance.

- 16 ounce heavy-coated hycar aprons.
- Resistance to animal fats and oils.
- Includes cloth neck strap, reinforced nickel plated brass grommets and 36-inch waist ties.
- 48 inches L x 35 inches W.
- Available in white, black and yellow.

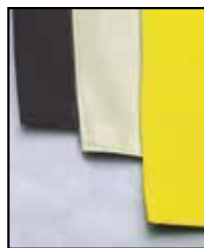

All edges are sewn.

ITEM NO.	COLOR
3279 10161	White
3279 10171	Black
3279 10181	Yellow

► 12 PER CASE.

EACH
\$24.27



### 22 Mil General Purpose Nitrile Apron

Economical, heavy-duty nitrile apron coated on both sides.

- Made of heavy-duty nitrile on a cotton base fabric.
- Snap-on neck band made of polypropylene.
- All edges are hemmed.
- Weight: 22 ounces.
- 48 inches L x 35 inches W.



Double-coated.

► 24 PER CASE.

ITEM NO.	COLOR	EACH
3419 90001	Yellow	\$27.09

SHOP [bunzlprocessor.com](http://bunzlprocessor.com) 24/7





## Chemical-Resistant Neoprene Apron

- Hemmed on all four sides.
- Adjustable cloth neck strap.
- 36-inch sewn ties.
- Dimensions:  
Maroon and White:  
35 inches W x 48 inches L.  
Yellow: 35 inches W x 45 inches L.



Snap-on cloth necks trap adjusts easily.

ITEM NO.	COLOR	THICKNESS
3279 22181	Maroon	16 oz.
3279 41321	White	16 oz.
3279 90201	Yellow	22 oz. (25 mil)

▶ 12 PER CASE.

**EACH**  
**\$25.74**

## 15 Mil Economy PVC Apron

*Light-weight, yet durable 15 mil PVC apron.*

- Made of 15-ounce PVC coated nylon fabric.
- Adjustable self-material neck band.
- String ties at waist, sewn edges and hem.
- 47 inches L x 35 inches W.
- Color: yellow.

ITEM NO.	COLOR
3296 12651	Yellow

▶ 48 PER CASE.

**EACH**  
**\$7.95**



**WARNING:** See inside front cover.  
www.P65Warnings.ca.gov.



## Vinyl Retail Apron

*Available in 6 easy-to-clean colors.*

- Vinyl remains pliable in temperatures down to -32 °F.
- 31 inches x 39 inches with pencil pocket on bib.
- Excellent moisture-resistance.
- Metal grommets at stress points; string ties at waist.
- 6 mil thickness.

ITEM NO.	COLOR
4465 91001	White
4465 91011	Red
4465 91021	Green
4465 91031	Blue
4465 91041	Clear
4465 91061	Yellow

▶ 12 PER CASE.

**CASE**  
**\$7.15**



Available in 6 colors.



**WARNING:** See inside front cover.  
www.P65Warnings.ca.gov.



# WorkHorse® Vinyl Aprons

Our best selling vinyl aprons.

- Protection from oil, fat, grease and salt.
- Made of quality vinyl with nylon-serged edges and four heat-sealed grommets.
- Ties in each apron.
- Width: 35 inches.

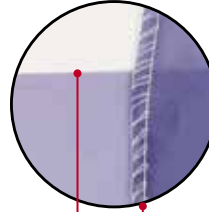

Raw edge.

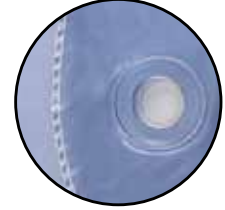

Heat sealed grommet and serged edges are easy to clean and maintain.

Sewn edge.

## A. Standard Tie Raw Edge ▶ 12 APRONS PER BAG - 6 BAGS PER CASE.

ITEM NO.	PRODUCT	DIMENSIONS	COLOR	BAG
E542 15255	Small	.35" x 45"	Blue	<b>\$24.39</b>
E542 15265	Medium	.35" x 48"	Blue	<b>24.99</b>
E542 15275	Large	.35" x 50"	Blue	<b>25.44</b>
E542 15285	X-Large	.35" x 55"	Blue	<b>28.20</b>

## A. Standard Tie Sewn Edge

ITEM NO.	PRODUCT	DIMENSIONS	COLOR	BAG
E542 15295	Small	.35" x 45"	Blue	<b>\$25.32</b>
E542 15305	Medium	.35" x 48"	Blue	<b>25.32</b>
E542 15315	Medium	.35" x 48"	White	<b>27.94</b>
E542 15325	Large	.35" x 50"	Blue	<b>26.08</b>
E542 15335	X-Large	.35" x 55"	Blue	<b>28.24</b>

## A. Premium Tie Sewn Edge

ITEM NO.	PRODUCT	DIMENSIONS	COLOR	BAG
E542 15355	Small	.35" x 45"	Blue	<b>\$28.32</b>
E542 15365	Medium	.35" x 48"	Blue	<b>30.83</b>
E542 15375	X-Large	.35" x 55"	Blue	<b>29.84</b>

## B. Standard Die Cut

ITEM NO.	PRODUCT	DIMENSIONS	COLOR	BAG
E542 15345	X-Small	.35" x 39"	Blue	<b>\$34.81</b>
E542 10985	Medium	.33" x 47"	Blue	<b>32.77</b>

## B. Premium Die Cut

ITEM NO.	PRODUCT	DIMENSIONS	COLOR	BAG
E542 15385	Medium	.35" x 48"	White	<b>\$49.00</b>



**WARNING:** See inside front cover or [www.P65Warnings.ca.gov](http://www.P65Warnings.ca.gov).

PRICES ARE SUBJECT TO CHANGE • MINIMUMS MAY APPLY • VISIT OUR WEBSITE FOR CURRENT PRICING.

# WorkHorse® Polyurethane Aprons

Outperforms disposable vinyl, neoprene and nitrile aprons.

- Enhanced anti-microbial properties
- Lightweight, yet puncture and tear resistant.
- Resistant to animal fats, degreasers and cleaning chemicals
- 100% water proof and recyclable
- Easy to clean/reuse
- Size: 35" x 50"



Self-material waist ties are long enough to tie in front or back.



Metal-detectable buckle.



One-piece, self-material neck strap and waist ties for added strength.



▶ 1 APRON PER BAG – 36 BAGS PER CASE.

## A. Standard (5.5-mil.) w/Buckle

ITEM NO.	COLOR	EACH
E542 15961	Blue	\$12.60
E542 15971	White	12.60
E542 15951	Yellow	12.60

▶ 1 APRON PER BAG – 24 BAGS PER CASE.

## A. Premium (8-mil.) w/Buckle

ITEM NO.	COLOR	EACH
E542 15941	Blue	\$21.18
E542 15891	White	21.18
E542 15981	Yellow	21.18

▶ 12 APRONS PER BAG – 3 BAGS PER CASE.

## B. Standard (5.5-mil.) Die Cut

ITEM NO.	COLOR	BAG
E542 15935	Blue	\$133.28
E542 15925	White	133.28
E542 15915	Yellow	133.28

▶ 12 APRONS PER BAG – 2 BAGS PER CASE.

## B. Premium (8-mil.) Die Cut

ITEM NO.	COLOR	BAG
E542 15885	Blue	\$212.22
E542 15995	White	212.22
E542 15905	Yellow	212.22



PRICES ARE SUBJECT TO CHANGE • MINIMUMS MAY APPLY • VISIT OUR WEBSITE FOR CURRENT PRICING.

# WorkHorse® Disposable Polyethylene Gowns

An economic, light-duty alternative in protective wear.

- Embossed. • Open back with ties.
- Two cuff options: elastic or thumb loop.
- Available in 1.25, 1.75 and 3 mil.



## 1.25 Mil

▶ 100 PER CASE - 36 CASES PER PALLET.

ITEM NO.	SIZE	COLOR	WRIST	CASE
E542 0519	Small/Tall, 38" x 55"	Blue	Elastic	\$94.23
E542 0520	Small/Tall, 38" x 55"	White	Elastic	93.82
E542 0938	Small/Tall, 38" x 55"	Blue	Thumb Loop	100.51
E542 0521	Small/Short, 38" x 45"	Blue	Elastic	89.96

## 1.75 Mil

▶ 25 PER PACK - 4 PACKS PER CASE - 36 CASES PER PALLET.

ITEM NO.	SIZE	COLOR	WRIST	CASE
E542 1050	Medium/Standard, 44" x 50"	Blue	Thumb Loop	\$123.27
E542 2255	Medium/Tall, 44" x 55"	Blue	Thumb Loop	133.34
E542 1046	Large/Short, 59" x 45"	White	Thumb Loop	128.29
E542 1155	Large/Tall, 59" x 55"	White	Thumb Loop	137.34

## 3 Mil

▶ 25 PER PACK - 4 PACKS PER CASE - 36 CASES PER PALLET.

ITEM NO.	SIZE	COLOR	WRIST	CASE
E542 0553	Small/Tall, 38" x 55"	Blue	Thumb Loop	\$137.34
E542 0353	Small/Tall, 38" x 55", Full Back	Blue	Thumb Loop	140.17

# Vinyl Replacement Gowns

Extruded triple layer material out performs comparable PVC and vinyl products 3:1.

- VR material is softer, flexible and lighter weight.
- Odorless, non-toxic and 100% recyclable.
- Gown interior is pebbled; no static electricity.
- 4 mil VR is as strong as to 6 mil PVC. 6 mil VR is as strong as to 8 mil PVC.
- Sizes:  
Regular: 38 inches x 45 inches.  
Large: 42 inches x 50 inches.  
X-Large: 42 inches x 55 inches.
- Available in thumb loop and elastic cuff styles.



Self-tie.

## Thumb Loop

▶ 50 PER CASE.

ITEM NO.	PRODUCT	SIZE	CASE
3386 6659	4 Mil, Blue	Regular	\$188.63
3386 0012	4 Mil, White	Regular	188.63
3386 6660	4 Mil, Blue	Large	228.92
3386 6661	4 Mil, Blue	X-Large	337.02
3386 6664	6 Mil, Blue	X-Large	472.71

## Elastic Wrist

ITEM NO.	THICKNESS	SIZE	CASE
3386 2454	4 Mil, Yellow	Regular	\$238.45
3386 2588	4 Mil, Red	X-Large	383.66
3386 5375	6 Mil, Blue	Large	364.58

PRICES ARE SUBJECT TO CHANGE • MINIMUMS MAY APPLY • VISIT OUR WEBSITE FOR CURRENT PRICING.

# WorkHorse® Polyethylene Disposable Sleeves

- Low-cost waterproof protection for light-duty, limited-use applications.



CLOTHING

## Standard 1 Mil Sleeves

▶ 2,000 PER CASE.

ITEM NO.	SIZE	COLOR	CASE
E542 0501	16" ...	Blue ...	<b>\$138.07</b>
E542 0499	16" ...	White ...	<b>138.07</b>
E542 0496	18" ...	Blue ...	<b>145.62</b>
E542 0500	18" ...	White ...	<b>145.62</b>

## Heavy-Duty 1.5 Mil Sleeves

▶ 100 SLEEVES PER BOX — 10 BOXES PER CASE.

ITEM NO.	SIZE	COLOR	CASE
E542 0789	18" ...	Clear ...	<b>\$129.17</b>
E542 0790	18" ...	Blue ...	<b>129.17</b>

# 18-Inch Vinyl Reusable Processing Sleeves

- Heat-sealed with enclosed elastic at each end.

▶ 12 PAIR PER BAG — 12 BAGS PER CASE.

## Standard Sleeves

ITEM NO.	COLOR	BAG
E542 15415	Clear ...	<b>\$15.29</b>
E542 15425	Blue ...	<b>15.29</b>

## Premium Sleeves

ITEM NO.	COLOR	BAG
E542 15435	Blue ...	<b>\$15.86</b>
E542 15445	Clear ...	<b>15.86</b>
E542 15455	White ...	<b>15.86</b>



**WARNING:** See inside front cover. [www.P65Warnings.ca.gov](http://www.P65Warnings.ca.gov).

# WorkHorse® Color-Coded Latex-Free Bouffant Caps

Color-coding your workplace has never been easier!

- Cool and comfortable to wear.
- Choose from seven colors for easy identification.

**SAVE BIG ON SMALL QUANTITIES!**  
You Won't Find A Better Deal On Bouffant Caps Anywhere!



▶ 100 PER BAG - 10 BAGS PER CASE.



LATEX FREE



ITEM NO.	COLOR	SIZE	BAG
E542 04615	White ...	18"	<b>\$4.97</b>
E542 04625	White ...	21"	<b>6.02</b>
E542 04635	White ...	24"	<b>6.58</b>
E542 04645	White ...	28"	<b>8.43</b>



ITEM NO.	COLOR	SIZE	BAG
E542 04655	Green ...	18"	<b>\$4.96</b>
E542 04665	Green ...	21"	<b>5.87</b>
E542 04675	Green ...	24"	<b>6.60</b>



ITEM NO.	COLOR	SIZE	BAG
E542 04695	Blue ...	18"	<b>\$4.96</b>
E542 04705	Blue ...	21"	<b>5.82</b>
E542 04715	Blue ...	24"	<b>6.60</b>



ITEM NO.	COLOR	SIZE	BAG
E542 04845	Pink ...	21"	<b>\$8.35</b>
E542 04855	Pink ...	24"	<b>8.95</b>



ITEM NO.	COLOR	SIZE	BAG
E542 04885	Red ...	21"	<b>\$5.94</b>
E542 04895	Red ...	24"	<b>6.81</b>



ITEM NO.	COLOR	SIZE	BAG
E542 04865	Yellow ...	21"	<b>\$5.94</b>
E542 04875	Yellow ...	24"	<b>6.81</b>



ITEM NO.	COLOR	SIZE	BAG
E542 03805	Orange ..	21"	<b>\$5.94</b>
E542 04455	Orange ..	24"	<b>6.81</b>





## WorkHorse® Poly Hood

A bouffant and beard guard all in one!

- Cool and comfortable to wear.
- 17 inches.

▶ 1,000 PER CASE.

ITEM NO.	PRODUCT	CASE
E542 0498	White .....	<b>\$171.35</b>
E542 0490	Orange .....	<b>180.71</b>

PRICES ARE SUBJECT TO CHANGE • MINIMUMS MAY APPLY • VISIT OUR WEBSITE FOR CURRENT PRICING.

# Neoprene Dipped, Waterproof Boots

Triple-dipped protection against harsh chemicals.

- Removable Breatheaprene® insoles provide shock absorption and moisture wicking.
- Steel toed boots meet ASTM F2413-18 M/I/C EH and ASTM F1671/F1671M-13.
- Plain toed boots meet ASTM F2892-18 M EH and ASTM F1671/F1671-13.
- Fabric-lined for easy on and off.

## A. 12 Inch

Plain Toe

ITEM NO.	MEN'S SIZE
3330 34041	Size 4
3330 34051	Size 5
3330 34061	Size 6
3330 34071	Size 7
3330 34081	Size 8
3330 34091	Size 9
3330 34101	Size 10
3330 34111	Size 11
3330 34121	Size 12
3330 34131	Size 13
3330 56441	Size 14

▶ 6 PAIR PER CASE.

PAIR  
**\$106.85**

## B. 12 Inch

Steel Toe

ITEM NO.	MEN'S SIZE
3330 22441	Size 4
3330 22451	Size 5
3330 22461	Size 6
3330 22471	Size 7
3330 22481	Size 8
3330 22491	Size 9
3330 22501	Size 10
3330 22511	Size 11
3330 22521	Size 12
3330 22531	Size 13
3330 56431	Size 14
3330 56451	Size 15

▶ 6 PAIR PER CASE.

PAIR  
**\$113.75**

## C. 15 Inch

Steel Toe

ITEM NO.	MEN'S SIZE
3330 55631	Size 3
3330 55641	Size 4
3330 79451	Size 5
3330 79461	Size 6
3330 79471	Size 7
3330 79481	Size 8
3330 79491	Size 9
3330 79501	Size 10
3330 79511	Size 11
3330 79521	Size 12
3330 79531	Size 13
3330 56421	Size 14
3330 79551	Size 15

▶ 6 PAIR PER CASE.

PAIR  
**\$116.95**



Open channels squeegee liquids, fats and debris out with each step.

# Neoprene Dipped, Waterproof Boots with Gusset

- Gusset provides calf flexibility.
- Meets ASTM F2413-18 M/I/C EH.
- Fabric-lined for easy on and off.
- Removable Breatheaprene® insoles provide shock absorption and moisture wicking.



SERVLIS®



V-wave pattern offers the best traction for areas with heavy debris.

ITEM NO.	MEN'S SIZE
3330 32331	Size 3
3330 32341	Size 4
3330 32351	Size 5
3330 32361	Size 6
3330 32371	Size 7
3330 32381	Size 8
3330 32391	Size 9
3330 32401	Size 10
3330 32411	Size 11
3330 32421	Size 12
3330 32431	Size 13
3330 32441	Size 14
3330 32451	Size 15

▶ 6 PAIR PER CASE.

PAIR  
**\$121.75**

# Neoprene Dipped, Waterproof, Insulated Boots

- Meets ASTM F2412-11 M I/75 C/75 and ASTM F1671/ F1671M - 13.
- Insulated boot has built-in foam insulation to keep feet warm and dry in low temperatures.
- Breathe-O-Prene® insole pulls moisture away from feet for all day comfort.



XTRATUF®



Open channel, slip-resistant, non-marking sole.

ITEM NO.	MEN'S SIZE
3330 22261	Size 4
3330 22271	Size 5
3330 22281	Size 6
3330 22291	Size 7
3330 22301	Size 8
3330 22311	Size 9
3330 22321	Size 10
3330 22331	Size 11
3330 22341	Size 12
3330 22351	Size 13
3330 22361	Size 14
3330 22371	Size 15

▶ 6 PAIR PER CASE.

PAIR  
**\$142.89**

PRICES ARE SUBJECT TO CHANGE • MINIMUMS MAY APPLY • VISIT OUR WEBSITE FOR CURRENT PRICING.

# FoodPro Steel Toe Boots

35% lighter than traditional rubber and PVC boots!

- Resistant to mineral, animal and vegetable oil, fats, blood, disinfectants and various chemicals.
- Highest slip resistant sole of any boot. Certified slip resistance (EN ISO 20345:2011 S4 CI SRC).
- Complies with CSA Z195-14 Omega, ASTM F2413-18 M/IC EH.
- Steel toe cap for added safety.
- Remains flexible at low temperatures.
- Shock-absorbing heel.
- Sole designed for specific food processing areas.
- Three colors to reduce cross-contamination.
- Seamed anti-bacterial lining. • 14-inch upper.
- Thermal insulation keeps feet warm in temperatures as low as -4 °F and comfortable in hot conditions.

**PUROFORT®**



CLOTHING

PUROFORT® is the unique Dunlop® material with millions of evenly distributed air pockets making it light-weight and thermally insulating plus a cross-linked structure that provides flexibility and strength. The material is created using a special

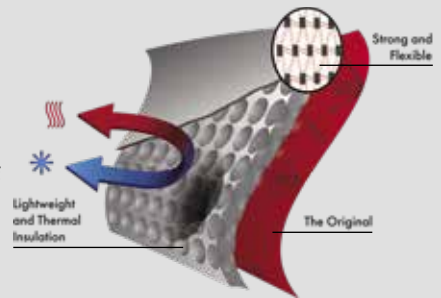

recipe at the time of manufacture, giving your Purofort® boots a "born on" date. This gives Purofort® boots their remarkable properties.



Unique feature allows boots to be locked together. (Separate lock required.)



## Brown

ITEM NO.	MEN'S SIZE
E014 01371	Size 3
E014 00801	Size 4
E014 00811	Size 5
E014 00821	Size 6
E014 00831	Size 7
E014 00841	Size 8
E014 00851	Size 9
E014 00861	Size 10
E014 00871	Size 11
E014 00881	Size 12
E014 00891	Size 13
E014 00901	Size 14
E014 00911	Size 15

## White

ITEM NO.	MEN'S SIZE
E014 00391	Size 3
E014 00401	Size 4
E014 00411	Size 5
E014 00421	Size 6
E014 00431	Size 7
E014 00441	Size 8
E014 00451	Size 9
E014 00461	Size 10
E014 00471	Size 11
E014 00481	Size 12
E014 00491	Size 13
E014 00501	Size 14
E014 00511	Size 15

F.O.B. FACTORY  
▶ 6 PAIR PER CASE.

PAIR  
**\$141.62**

F.O.B. FACTORY  
▶ 6 PAIR PER CASE.

PAIR  
**\$141.62**



Scan this QR code with your mobile device to watch a video about Purofort® Boots.



Multi-grip Safety Sole: SRC rated for best slip resistance.

PRICES ARE SUBJECT TO CHANGE • MINIMUMS MAY APPLY • VISIT OUR WEBSITE FOR CURRENT PRICING.

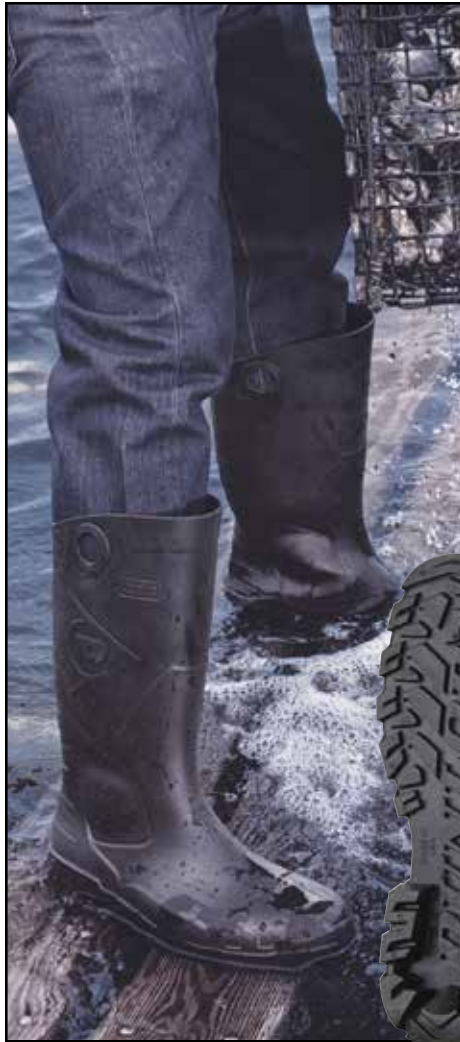

## Chesapeake® Boots

Light and mighty with outsole that channels to repel water.

- Steel toe complies with ASTM F2413-11 standard.
- 25% lighter than classic PVC boots.
- 100% waterproof. • 14-inch upper.
- Color: black.

Pull tab for easy donning and doffing.



### Plain Toe

ITEM NO.	MEN'S SIZE
E014 00921	Size 3
E014 00931	Size 4
E014 00941	Size 5
E014 00951	Size 6
E014 00961	Size 7
E014 00971	Size 8
E014 00981	Size 9
E014 00991	Size 10
E014 01001	Size 11
E014 01011	Size 12
E014 01171	Size 13
E014 01181	Size 14
E014 01191	Size 15

▶ 6 PAIR PER CASE.

PAIR  
**\$29.30**

### Steel Toe

ITEM NO.	MEN'S SIZE
E014 01201	Size 3
E014 01211	Size 4
E014 01221	Size 5
E014 01231	Size 6
E014 01241	Size 7
E014 01251	Size 8
E014 01261	Size 9
E014 01271	Size 10
E014 01281	Size 11
E014 01291	Size 12
E014 01301	Size 13
E014 01311	Size 14
E014 01321	Size 15

▶ 6 PAIR PER CASE.

PAIR  
**\$33.83**

Energy absorbing BAY-LOC outsole with channels to repel water.



## White, Steel Toe PVC Boots

PVC upper provides mild chemical resistance and helps comply with HACCP guidelines.

- 16-inch upper with cut-off bands for height adjustment.
- Built in steel shank for all day comfort.
- Pull-up and kick-off lugs.
- Steel toe meets ASTM F2413-11.
- Color: white.



**MIX & MATCH SIZES**  
TO MAKE YOUR CASE AND SAVE!

ITEM NO.	MEN'S SIZE
3161 51541	Size 4
3161 51551	Size 5
3161 51561	Size 6
3161 51571	Size 7
3161 51581	Size 8
3161 51591	Size 9
3161 51601	Size 10
3161 51611	Size 11
3161 51621	Size 12
3161 51631	Size 13

▶ 6 PAIR PER CASE.

PAIR  
**\$47.05**

**NOTE: Our boots can be ordered and worn by men or women. There is a two size difference between men's and women's sizes. A woman ordering a boot should order two sizes smaller than her regular size. Example: women's size 9 would order men's size 7.**



# Vikan® Ultra Safe Technology (UST) Scrub Brushes

UST provides a new level of hygienic design and bristle arrangement.

- One piece design, no metal staples or resin.
- Easy color-coded visual inspection.
- Easy to clean and dry.

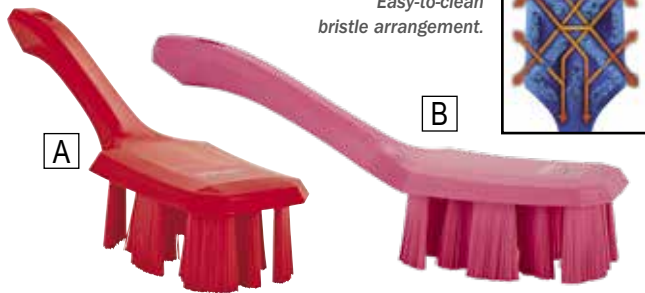

## A. Short Handle

ITEM NO.	COLOR
5281 00381	Pink
5281 00281	Green
5281 00391	Blue
5281 00291	Red
5281 00301	White
5281 00311	Yellow
5281 00401	Orange
5281 00411	Purple

EACH  
**\$22.20**

## B. Long Handle

ITEM NO.	COLOR
5281 00431	Pink
5281 00441	Green
5281 00451	Blue
5281 00461	Red
5281 00471	White
5281 00481	Yellow
5281 19671	Orange
5281 00491	Purple

EACH  
**\$27.50**



# Vikan® Total Color Scrub Brushes

Choose from three styles and multiple colors.

- Low water absorption polyester bristles with stainless steel staples.
- Autoclavable at temperatures up to 250 °F/121 °C.
- Hygienic, solid block polypropylene construction.
- Made from FDA-compliant materials.



## Scrub Brush, Stiff

2-1/2 inches x 7-1/2 inches

ITEM NO.	COLOR
5281 89051	White
5281 89041	Red
5281 89061	Yellow
5281 89021	Green
5281 89031	Blue
5281 89071	Orange
5281 89081	Purple
5281 89091	Black



EACH  
**\$15.84**

## Short Handle, Stiff

3 inches x 10 inches

ITEM NO.	COLOR
5281 19251	White
5281 19241	Red
5281 19261	Yellow
5281 19221	Green
5281 19231	Blue
5281 19271	Orange
5281 19281	Purple
5281 19291	Black
5281 04011	Pink
5281 04021	Brown
5281 03311	Lime
5281 04031	Gray

EACH  
**\$13.72**



## Long Handle, Stiff

2-3/4 inches x 15-3/4 inches

ITEM NO.	COLOR
5281 18651	White
5281 18641	Red
5281 18661	Yellow
5281 18621	Green
5281 18631	Blue



EACH  
**\$14.79**

# Sparta® Tank and Kettle Brush

- Flared head ensures all-around thorough cleaning.
- Crimped, non-absorbent polyester bristles are stapled into the block for increased durability.
- Foam-injected plastic block provides additional durability.
- 5-1/2 inches x 9-1/2 inches.
- Bristle trim: 1-3/4 inches.
- Temperature range: -40° to 125 °F.
- FDA-compliant.

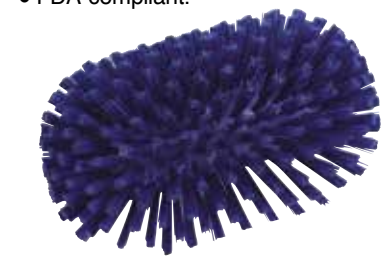

NOTE: Brush and handle sold separately.

## Brush

ITEM NO.	COLOR
6387 20741	Red
6387 20711	Orange
6387 20771	Yellow
6387 20701	Lime
6387 20691	Green
6387 20661	Blue
6387 20731	Purple
6387 20721	Pink
6387 20751	Tan
6387 20761	White
6387 20681	Gray
6387 20651	Black
6387 20671	Brown

▶ 12 PER CASE  
EACH  
**\$41.84**

## 60 Inch Handle

ITEM NO.	COLOR
6387 21621	Red
6387 21671	Orange
6387 21641	Yellow
6387 21661	Lime
6387 21611	Green
6387 21591	Blue
6387 21691	Purple
6387 21681	Pink
6387 21701	Tan
6387 21631	White
6387 21651	Gray
6387 21581	Black
6387 21601	Brown

▶ 12 PER CASE  
EACH  
**\$20.82**



CLEANING/HYGIENE

PRICES ARE SUBJECT TO CHANGE • MINIMUMS MAY APPLY • VISIT OUR WEBSITE FOR CURRENT PRICING.

## Vikan® Extra-Stiff Angle Cut Brooms

Angled design to reach into narrow spaces.

- It is particularly effective for collecting large particles of debris like meat and vegetables in a moist environment.
- Polypropylene block material with polyester bristles.
- Length: 12 inches.

NOTE: See page 19 for handles, sold separately.



ITEM NO.	COLOR
5281 91451	White
5281 91461	Yellow
5281 01261	Orange
5281 91441	Red
5281 06551	Purple
5281 91431	Blue
5281 91421	Green
5281 06561	Brown
5281 06571	Gray
5281 00351	Black

► 10 PER CASE.

EACH  
**\$29.63**



## Vikan® Color-Coded Dustpans

Color-coded to help organize your workplace.

- Rigid, one-piece, injection-molded polypropylene construction.
- Ergonomic raised-handle design with thumb grip.
- Non-sparking material will not rust or corrode.
- Made from FDA-compliant materials.



ITEM NO.	COLOR	ITEM NO.	COLOR
5281 66051	White	5281 66031	Blue
5281 66061	Yellow	5281 04671	Lime
5281 66071	Orange	5281 66021	Green
5281 66041	Red	H710 00791	Brown
5281 02461	Pink	5281 04681	Gray
5281 66091	Purple	5281 66101	Black

► 10 PER CASE.

EACH  
**\$17.97**



## Vikan® Total Color Deck Brushes

- Hygienic, solid block polypropylene construction with stiff bristles.
- Low water absorption polyester bristles with stainless steel staples.
- Autoclavable at temperatures up to 250 °F/121 °C.
- Made from FDA-compliant materials.
- Block size: 3 inches x 12 inches.
- Bristle length: 1-3/4 inches.



NOTE: See page 19 for handles, sold separately.

ITEM NO.	COLOR
5281 16051	White
5281 0606	Yellow
5281 06071	Orange
5281 0604	Red
5281 02471	Pink
5281 06081	Purple
5281 0603	Blue
5281 04691	Lime
5281 06021	Green
H710 00801	Brown
5281 04701	Gray
5281 16091	Black



► 16 PER CASE.

EACH  
**\$39.17**



# Vikan® One-Piece Ultra Hygiene Squeegees

- One-piece design and co-molded construction eliminates areas that could harbor bacteria.
- Specially blended rubber blade retains its flexibility and durability and is useful on a variety of work surfaces.
- Reinforced polypropylene head.
- Made from FDA-compliant materials.



CLEANING/HYGIENE

► SEE BELOW

Vikan® Handles Sold Separately.



Scan this QR code with your mobile device to watch a video about Vikan® squeegees.



## 10 Inch

ITEM NO.	COLOR
5281 07401	Green
5281 12531	Blue
5281 07421	Red
5281 12551	White
5281 07441	Yellow
5281 07451	Orange
5281 12581	Purple
5281 03191	Pink

EACH  
**\$22.20**



10-inch squeegee includes a matching 6.3-inch threaded Vikan® mini handle with a one-piece sealed-design.

## 16 Inch

ITEM NO.	COLOR
5281 07461	Green
5281 07471	Blue
5281 07481	Red
5281 07491	White
5281 07501	Yellow
5281 03481	Orange
5281 01251	Black
5281 01811	Purple
5281 14011	Pink
5281 04261	Brown
5281 04271	Lime
5281 04341	Gray

EACH  
**\$30.69**

## 24 Inch

ITEM NO.	COLOR
5281 07681	Green
5281 07571	Blue
5281 07581	Red
5281 07591	White
5281 07601	Yellow
5281 16071	Orange
5281 07621	Black
5281 07611	Purple
5281 02451	Pink
H710 00761	Brown
5281 04281	Lime
H710 00851	Gray

EACH  
**\$39.17**

► ALL SIZES, 15 PER CASE.

## 20 Inch

ITEM NO.	COLOR
5281 07511	Green
5281 07521	Blue
5281 07531	Red
5281 07541	White
5281 07551	Yellow

EACH  
**\$36.00**

## 28 Inch

ITEM NO.	COLOR
5281 07631	Green
5281 07641	Blue
5281 07651	Red
5281 07661	White
5281 07671	Yellow

EACH  
**\$44.46**

**MIX & MATCH COLORS TO MAKE YOUR CASE AND SAVE!**

## Vikan® Ultra Hygiene Poly Handles

- Made of food-grade polypropylene.
- Safe alternative to fiberglass handles.
- Easy to clean rounded grip handles.
- Hygienic smooth surface, sealed to prevent bacterial growth.
- Larger diameter ergonomic handle shape reduces worker fatigue.



Euro thread.



Hygienic design with smooth surface, sealed to prevent bacterial growth.



## 51 Inch

ITEM NO.	COLOR
5281 86051	White
5281 96061	Yellow
5281 86071	Orange
5281 16041	Red
5281 96011	Pink
5281 96081	Purple
5281 86031	Blue
5281 86021	Green
5281 96091	Black

EACH  
**\$30.70**

## 59 Inch

ITEM NO.	COLOR
5281 96301	White
5281 96321	Yellow
5281 86271	Orange
5281 16241	Red
5281 96211	Pink
5281 86281	Purple
5281 16231	Blue
5281 03351	Lime
5281 86221	Green
H710 00991	Brown
5281 04291	Gray
5281 96311	Black



PRICES ARE SUBJECT TO CHANGE • MINIMUMS MAY APPLY • VISIT OUR WEBSITE FOR CURRENT PRICING.

## Mid-Sized Hot Water Nozzles

Designed for use in the food processing industry and built to withstand the harshest working conditions.

- Heavy-duty body with stainless steel and brass components.
- Replacement parts available. • 3/4-inch female GHT.
- Trigger controlled variable spray pattern that instantly shuts off when trigger is released.
- Insulated rubber cover with direction arrows.
- Maximum water temperature: 200 °F/93 °C.
- Maximum working pressure: 150 psi.
- Flow rates: 2.5 - 7 gpm.



Can be used with our Industrial Foamer. See your Buyers Guide, call or visit our website for details.



Outlet cover can be unscrewed for GHT access.

### VARIABLE SPRAY NOZZLES

Trigger lever controls variable spray pattern.



Wide spray.



Narrow spray.



Tight stream.

### Brass Body

ITEM NO.	COLOR
3013 30011	Orange
3013 21001	White
3013 21011	Black
3013 00951	Red
3013 00971	Yellow

EACH  
**\$87.62**

### Aluminum Body

ITEM NO.	COLOR
3013 89011	Orange
3013 89031	White
3013 89021	Black
3013 01271	Red
3013 01241	Yellow

EACH  
**\$78.05**

### Stainless Steel Body

and Components

ITEM NO.	COLOR
3013 89111	Orange
3013 01171	White
3013 01191	Black
3013 01001	Red
3013 01151	Yellow

EACH  
**\$120.78**



**NOTE:** These nozzles connect directly to garden hose threads with no adapter needed OR add a swivel adapter (sold separately) to extend hose life and prevent kinking. See ordering information above.



## Hot Water Packinghouse Hose

Multiple textile spirals reinforces hose and extends hose life. **FREE WITH THIS HOSE** — rubber insulators that keep the hose cool to the touch.

- Couplings are securely attached to each end of the hose with no sharp edges and are covered by a heavy-duty reinforcement insulator to prevent failure at the base of the hose and to keep the ends cool to the touch.
- Hose assemblies are pre coupled with garden hose couplings on each end.
- Withstands 500 psi. • Withstands temperatures up to 212 °F.
- Highly-resistant to cuts and abrasions.
- Available in 3/4 inch ID and 1/2 inch ID.



**FREE** rubber insulator keeps hose cool to the touch.

Double braided nylon reinforced.

ITEM NO.	LENGTH	SIZE	EACH
3538 7108	25'	1/2" ID w/GHT Couplings Each End ...	<b>\$163.63</b>
3538 7109	50'	1/2" ID w/GHT Couplings Each End ...	<b>274.92</b>
3538 7100	100'	1/2" ID w/GHT Couplings Each End ...	<b>511.93</b>
3538 2025	25'	3/4" ID w/GHT Couplings Each End ...	<b>220.70</b>
3538 2050	50'	3/4" ID w/GHT Couplings Each End ...	<b>360.99</b>
3538 2075	75'	3/4" ID w/GHT Couplings Each End ...	<b>543.10</b>
3538 4085	85'	3/4" ID w/GHT Couplings Each End ...	<b>648.81</b>
3538 0100	100'	3/4" ID w/GHT Couplings Each End ...	<b>723.72</b>

MADE IN USA



# ToteAll 2000<sup>®</sup>

## Molded Poly Boxes

- Max temp: 410 °F/210 °C.
- 4:1 nesting ratio saves space.

MATERIAL HANDLING



**50 Pound Capacity**  
Weighs only 3.8 pounds empty  
1.3 cubic feet



90° cross stacking via stacking grooves built into bottom of tote.



Smooth interior and wide radius corners for easy cleaning.

Stacking grooves allows cross stacking.

Molded-in handles.

Reinforced nesting-stops prevent jamming.

Wall thickness - 0.125"

Finely etched exterior resists cuts and scratches.

ITEM NO.	COLOR
3195 06641	Orange
3195 2013	Tan
3195 46331	Yellow
3195 46351	Green
3195 46341	Blue
3195 00021	Purple
3195 46321	Red
3195 73041	Pink
3195 07071	White
3195 06621	Gray
3195 46361	Black

EACH  
**\$13.95**

**OUR TOTEALL 2000<sup>®</sup> POLY BOXES** are a first-class product with ribs along the bottom lifting ledge to increase the strength of the ledge when it's used in tote dollies. These reinforcements make our first-class tote a level above our competitors.

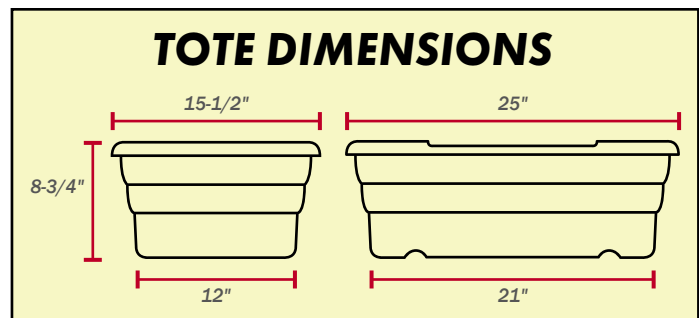

## Poly Tote Liners

**CALL to request a FREE SAMPLE!**

Clean-ups have never been easier! Liners are approved for food contact.

- Liners eliminate the need for cleaning totes — just pull off the used liner and throw away!
- Blue, 1.5 mil polyethylene liners fit all ToteAll 2000<sup>®</sup> totes.

► 500 PER CASE.

ITEM NO.	PRODUCT	DIMENSIONS	CASE
E179 2215	Blue Tote Liners	22" x 15" x 20"	<b>\$199.98</b>

PRICES ARE SUBJECT TO CHANGE • MINIMUMS MAY APPLY • VISIT OUR WEBSITE FOR CURRENT PRICING.

# Round Food-Approved Drums and Lids

- Durable construction reinforced with drag skids for maximum longevity. • Integrated ergonomic handles.
- Unique base handles allow for easy lifting. • Special features prevent vacuum sealing when nesting.
- Guaranteed to never fade, warp, crack or crush. • NSF 2 and 21 certified.



## 10-Gallon Drums and Lids

WHITE	YELLOW	ORANGE	RED	PINK	PURPLE	BLUE	GREEN	GRAY	BLACK	▶ 6 PER CASE.	
ITEM NO.	ITEM NO.	ITEM NO.	ITEM NO.	ITEM NO.	ITEM NO.	ITEM NO.	ITEM NO.	ITEM NO.	ITEM NO.	PRODUCT	EACH
6387 24401	6387 24421	6387 24471	6387 24431	6387 24481	6387 24491	6387 24451	6387 24441	6387 24461	6387 24411	Drum . . . . .	<b>\$21.62</b>
6387 24511	6387 24531	6387 24581	6387 24541	6387 24591	6387 24611	6387 24561	6387 24551	6387 24571	6387 24521	Lid . . . . .	<b>9.35</b>

## 20-Gallon Drums and Lids

WHITE	YELLOW	ORANGE	RED	PINK*	PURPLE	BLUE	GREEN	GRAY	BLACK	▶ 6 PER CASE.	
ITEM NO.	ITEM NO.	ITEM NO.	ITEM NO.	ITEM NO.	ITEM NO.	ITEM NO.	ITEM NO.	ITEM NO.	ITEM NO.	PRODUCT	EACH
6387 24631	6387 24651	6387 25251	6387 24661	6387 25261	6387 25271	6387 24681	6387 24671	6387 24691	6387 24641	Drum . . . . .	<b>\$31.69</b>
6387 24701	6387 24731	6387 24781	6387 24741	6387 24791	6387 24811	6387 24761	6387 24751	6387 24771	6387 24721	Lid . . . . .	<b>12.53</b>

## 32-Gallon Drums and Lids

WHITE	YELLOW	ORANGE	RED	PINK*	PURPLE*	BLUE	GREEN	GRAY	BLACK	▶ 4 PER CASE.	
ITEM NO.	ITEM NO.	ITEM NO.	ITEM NO.	ITEM NO.	ITEM NO.	ITEM NO.	ITEM NO.	ITEM NO.	ITEM NO.	PRODUCT	EACH
6387 24831	6387 24851	6387 24901	6387 24861	6387 24911	6387 24921	6387 24881	6387 24871	6387 24891	6387 24841	Drum . . . . .	<b>\$42.08</b>
6387 24941	6387 24961	6387 25081	6387 24971	6387 25101	6387 25151	6387 24991	6387 24981	6387 25071	6387 24951	Lid . . . . .	<b>16.62</b>

## 44-Gallon Drums and Lids

WHITE	YELLOW	ORANGE	RED	PINK*	PURPLE*	BLUE	GREEN	GRAY	BLACK	▶ 6 PER CASE.	
ITEM NO.	ITEM NO.	ITEM NO.	ITEM NO.	ITEM NO.	ITEM NO.	ITEM NO.	ITEM NO.	ITEM NO.	ITEM NO.	PRODUCT	EACH
6387 32701	6387 32711	6387 32791	6387 32721	6387 25331	6387 25341	6387 32741	6387 32731	6387 32761	6387 14761	Drum . . . . .	<b>\$57.95</b>
6387 25441	6387 25461	6387 25511	6387 25471	6387 25521	6387 25531	6387 25491	6387 25481	6387 25501	6387 25451	Lid . . . . .	<b>23.52</b>

## 55-Gallon Drums and Lids

WHITE	YELLOW	ORANGE*	RED	PINK*	PURPLE*	BLUE	GREEN	GRAY	BLACK	▶ 2 PER CASE.	
ITEM NO.	ITEM NO.	ITEM NO.	ITEM NO.	ITEM NO.	ITEM NO.	ITEM NO.	ITEM NO.	ITEM NO.	ITEM NO.	PRODUCT	EACH
6387 05481	6387 09421	6387 25411	6387 09401	6387 25621	6387 05221	6387 09411	6387 55111	6387 55231	6387 15221	Drum . . . . .	<b>\$87.95</b>
6387 25641	6387 25661	6387 25751	6387 25671	6387 25721	6387 25731	6387 25701	6387 25691	6387 25711	6387 25651	Lid . . . . .	<b>34.94</b>

\*Certain sizes of orange, pink and purple drums and lids are available by special order. Minimum quantities apply. Ask your CSR for details.

# Plastic Shovels



MATERIAL HANDLING

- Sturdy injection molded one-piece polypropylene.
- Features a solid shaft and extra thick blade.
- Non-sparking. • Made from FDA compliant materials.
- Chemical- and corrosion-resistant.
- Small Blade: 11 inches x 14 inches;  
Overall length: 38 inches; Weight: 2-7/10 pounds.
- Large Blade: 14 inches x 17 inches;  
Overall length: 42 inches; Weight: 4 pounds.



## Small Blade

ITEM NO.	COLOR	
5281 98101	White	
5281 69801	Yellow	
5281 01081	Orange	
5281 00081	Red	
5281 00271	Pink	
5281 01091	Purple	
5281 98131	Blue	
5281 04791	Lime	
5281 98121	Green	
5281 04781	Brown	▶ 6 PER CASE.
5281 04801	Gray	<b>EACH</b>
5281 01481	Black	<b>\$42.35</b>

## Large Blade

ITEM NO.	COLOR	
5281 98251	White	
5281 69891	Yellow	
5281 98271	Orange	
5281 69831	Red	
5281 01591	Pink	
5281 69921	Purple	
5281 69881	Blue	
5281 04951	Lime	
5281 69901	Green	
5281 04941	Brown	▶ 6 PER CASE.
5281 04961	Gray	<b>EACH</b>
5281 98291	Black	<b>\$43.41</b>

### HOW TO CALCULATE REPLACEMENT CUTTING BOARDS

1. Measure length and width in inches.
2. Multiply length x width for total square inches.
3. Divide total square inches by 144.
4. Round calculation up to the nearest foot.
5. Take that number x price per square foot.

**L x W = Total Square Inches**

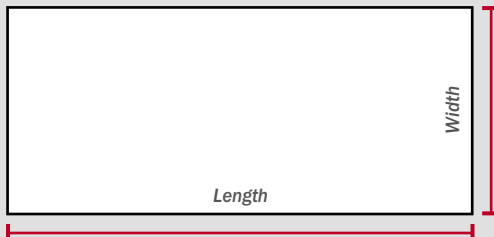

#### Example:

1. Board desired is 13 inches W x 76 inches L.
2. 13 inches x 76 inches = 988 square feet.
3. 988 divided by 144 = 6.86.
4. Round 6.86 up to nearest foot = 7.
5. Total price = 7 x price of board per square foot.

**We recommend boards no larger than 18 inches W x 5 feet L, removable for cleaning by a single worker.**

## Sanatec® Poly Cutting Board Table Tops

An economical alternative to wood surfaces.



- Made of sanitary polyethylene with a reversible slip-resistant pebble finish that won't dull knives.
- Surface will not absorb odors – clean with soap and water.
- Select from four thicknesses, sold per square foot.



**CUSTOM CUT to any size or shape to fit your table!**

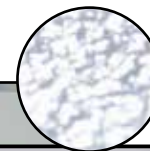

Slip-resistant textured surface.

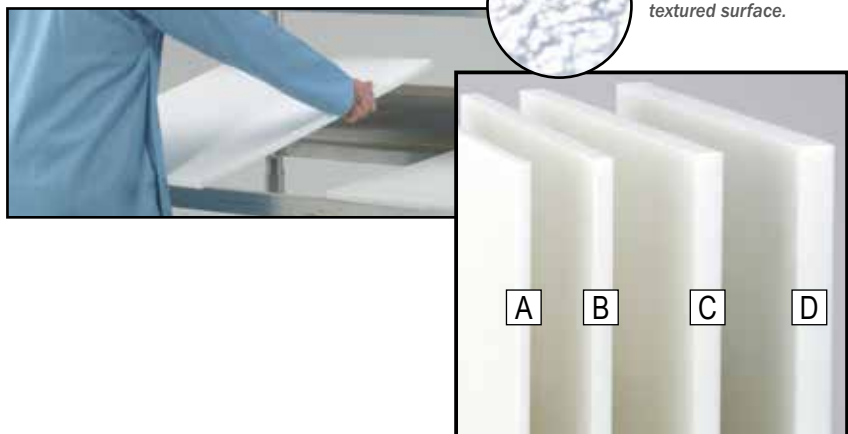

ITEM NO.	PRODUCT	SQ. FT.	F.O.B. FACTORY
3201 1424	A. 1/4" Cutting Board.....		<b>\$18.55</b>
3201 2094	B. 1/2" Cutting Board.....		<b>31.64</b>
3201 1425	C. 3/4" Cutting Board.....		<b>35.36</b>
3201 1426	D. 1" Cutting Board.....		<b>42.70</b>

Call for information on calculating dimensions for replacement cutting boards. Boards 3' x 4' or smaller ship UPS. Larger boards are shipped via freight line.

PRICES ARE SUBJECT TO CHANGE • MINIMUMS MAY APPLY • VISIT OUR WEBSITE FOR CURRENT PRICING.

# ChillTote™ Trays



- ChillTotes™ fit four-up on standard 42-inch x 48-inch pallets.
- Light-weight freezer proof, stackable/nestable and easy to clean.
- Flow-thru basket allows maximum air circulation for faster, more efficient freezing.
- Heavy ribs on bottoms of trays prevent the contents of upper and lower trays from freezing together.
- Injection molded from high-density polyethylene to withstand constant freezer temperatures without cracking or warping.
- Capacity: Standard: 1.4 cubic feet, 50 pounds; Deep: 2.9 cubic feet, 75 pounds.

ITEM NO.	PRODUCT	DIMENSIONS	EACH
1814 28631	Standard ChillTote™	22" x 19" x 6"	\$30.61
1814 58901	Deep ChillTote™	24" x 20" x 13"	52.91



Two 3/8 inch zinc-plated steel wire bails swing down to allow nesting and swing up for stacking.

**MAXIMUM AIR CIRCULATION.**

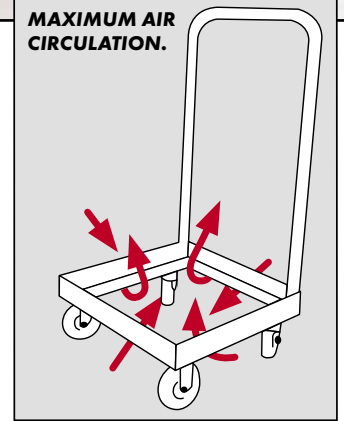

**NOTE: ChillTote™ trays sold separately. SEE ABOVE.**

# Heavy-Duty ChillTote™ Dollies

- Heavy-duty aluminum dollies make a portable chill system.
- Two swivel and two rigid casters with durable 5-inch heavy-duty wheels. Uses 2F and 2G casters.
- Load capacity: 750 pounds.

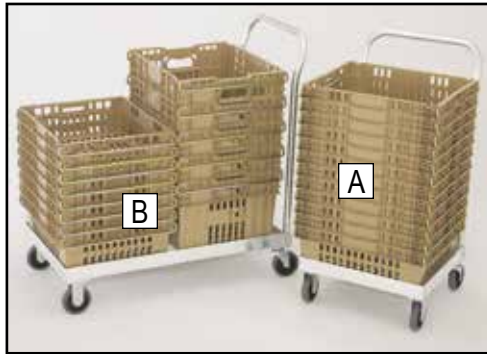

ITEM NO.	PRODUCT	DIMENSIONS	SHIPPING WT.	EACH
3775 2860	A. Single	22-1/4" x 22-1/2" x 8-1/2"	14 lb.	\$279.96
3775 2861	B. Double	22-1/4" x 42-1/2" x 8-1/2"	20 lb.	298.07
3775 2862	Optional 35" Handle			62.69

► [BUNZLPROCESSOR.COM](http://BUNZLPROCESSOR.COM)

**OUR FREEZER TOTE SPREADER IS IDEAL FOR STACKING AND PALLETIZING FREEZER TOTES.**

**ITEM# 3502 53441**



# ChillTote™ Dollies



- For use in moving and storing ChillTotes™.
- Open corners for easy cleaning • Will not rust.
- Strong, durable aluminum construction with four 3-inch swivel casters.
- Shipping weight: 15 pounds.



**NOTE: ChillTote™ trays sold separately. SEE ABOVE.**

ITEM NO.	PRODUCT	DIMENSIONS	EACH
3775 9322	Dolly	23-1/2" x 19" x 6"	\$151.77



# 5-Gallon Food-Approved Plastic Bucket

- Lid available in white only and has tear-tabs for easier openings.
- 90 mil heavy-duty polyethylene.
- FDA compliant for contact with food products.



Buckets have child warning labels.

ITEM NO.	COLOR	EACH
2316 00231	White	12 PER CASE. \$24.55
2316 00221	Red	
2316 00201	Blue	
2316 00211	Green	
2316 00241	Yellow	
2316 00191	Black	

ITEM NO.	PRODUCT	EACH
2316 00181	Lid, White	\$7.75





# MACX™ Storage System

The durability and versatility of steel for the cost of plastic.

- Light-weight, yet strong enough to hold 1,500 pounds of product.
- Will not warp, dent, chip, splinter, rot or rust and are chemical and corrosion-resistant.
- One-piece, injection molded construction.
- Made from high-density, food-grade structural plastic with a service life comparable to steel.
- Withstands temperatures from -32 °F to +165 °F.
- Completely sanitary: can be high-pressure washed and steam sterilized.
- Drain and cap are available for liquid applications.
- Capacity: single bin, unstacked, static weight of 1,500 pounds.
- Shipping weight: 89 pounds.
- 48 inch x 40 inch standard pallet footprint.
- 25.4 cubic feet; 190 US gallons.

**NOTE: Customizable: add casters, drain plugs, label holders, drop doors, attachable lids, custom colors and even emboss your company logo on the side. Call for more information.**



MACX™ come standard with runners — easy for dumping or moving with a forklift.



Optional drain and cap kit.



ITEM NO.	PRODUCT	F.O.B. FACTORY EACH
3515 5732	Storage Bin, Solid, Gray . . . . .	\$330.67
3515 5736	Storage Bin, Solid, White. . . . .	352.51
3515 0052	Storage Bin, Vented, Gray. . . . .	274.51
3515 5862	Stacking Lid, White . . . . .	103.95
3515 5863	Drain and Cap Kit (For DIY Installation) . . . . .	44.67

10-high maximum stacking.

## Distribution Totes

The only tote accepted by many retail food operations.

- Complies with sanitation and material handling requirements of many retail food processors.
- Sturdy design has reinforced ribs and deep molded hand grips for convenient lifting and carrying.
- For use in refrigerated trailers, freezers and walk-in storage coolers.
- Withstand temperatures from -20 °F to 120 °F.
- Stack with optional covers, nest when empty.
- Cross-stack and interlock on a 40 inch x 48 inch pallet.
- Made of injection-molded polyethylene.
- FDA compliant.
- Color: beige.



ITEM NO.	PRODUCT	DIMENSIONS	CAPACITY	EACH
1814 41681	Tote, Standard. . . . .	24" x 16" x 8.7"	40 lb. . . . .	\$24.95
1814 07681	Tote, Large . . . . .	24" x 16" x 10-3/4"	55-60 lb . . . . .	26.95
1814 07701	Lid, Standard. . . . .	24" x 16" x 1-1/2"		14.37
1814 9014	Lid, Large . . . . .	24-3/10" x 16-3/10" x 1-4/5"		17.95

## Molded Plastic Freezer Spacer

- Unique design features holes throughout to decrease freezing times.
- Raised nubs along the edge keep boxes from sliding off.
- Shipping weight: 4-1/5 pounds, 2,000 pound capacity.
- Shipping weight: 4-2/5 pounds, 3,000 pound capacity.
- 40 inches x 48 inches.

▶ 500 PER PALLET.

ITEM NO.	PRODUCT	DIMENSIONS	CAPACITY	EACH
K188 00011	Freezer Spacer . . . . .	40" x 48"	2,000 lb . . . . .	\$18.51

▶ 400 PER PALLET.

ITEM NO.	PRODUCT	DIMENSIONS	CAPACITY	EACH
2992 3818	Anti-Slip Spacer. . . . .	40" x 48"	3,000 lb . . . . .	\$20.00

▶ 300 PER PALLET.

ITEM NO.	PRODUCT	DIMENSIONS	CAPACITY	EACH
2992 4840	w/o Anti Slip. . . . .	40" x 48"	3,000 lb . . . . .	\$21.89



# WorkHorse® Cut-Resistant Gloves

Constructed of spun threads with fully encapsulated glass fibers and stainless steel.

- Exceptional comfort that is 100% latex and silicone free.
- Resistant to acids, alkali and organic solvents.
- FDA-compliant antimicrobial fibers meet USDA food handling requirements.
- Extended cuff offers extra cut protection around the wrist.
- Machine washable. • Antimicrobial fiber. • Ambidextrous.
- Sold per glove, 6 gloves per case.



Cuff edge color indicates size.

## ANSI/ISEA 105-2016 Rating Chart



Higher the cut level = more cut protection

Cut Level	Weight* (grams)
	0 - 199
<b>A1</b>	200-499
<b>A2</b>	500-999
<b>A3</b>	1000-1499
<b>A4</b>	1500-2199
<b>A5</b>	2200-2999
<b>2</b>	3000-3999
<b>A7</b>	4000-4999
<b>A8</b>	5000-5999
<b>A9</b>	6000+

\*Weight needed to cut through material with 25 mm of blade travel.

## GAUGE LEVEL

Gauge indicates thickness of threads used in the glove.

Higher the gauge = thinner threads for more flexibility.



## A4



### Standard Cuff

#### Gray

ITEM NO.	SIZE	CUFF
E542 85001	X-Small	Green
E542 85011	Small	White
E542 85021	Medium	Red
E542 85031	Large	Blue
E542 85041	X-Large	Orange

#### White

ITEM NO.	SIZE	CUFF
E542 85051	X-Small	Green
E542 85061	Small	White
E542 85071	Medium	Red
E542 85081	Large	Blue
E542 85091	X-Large	Orange

GLOVE  
**\$9.95**

## A5



### Standard Cuff

#### Gray

ITEM NO.	SIZE	CUFF
E542 85101	X-Small	Green
E542 85111	Small	White
E542 85121	Medium	Red
E542 85131	Large	Blue
E542 85141	X-Large	Orange

#### White

ITEM NO.	SIZE	CUFF
E542 85151	X-Small	Green
E542 85161	Small	White
E542 85171	Medium	Red
E542 85181	Large	Blue
E542 85191	X-Large	Orange

GLOVE  
**\$8.95**



### Standard Cuff

#### Gray

ITEM NO.	SIZE	CUFF
E542 85201	X-Small	Green
E542 85211	Small	White
E542 85221	Medium	Red
E542 85231	Large	Blue
E542 85241	X-Large	Orange

#### White

ITEM NO.	SIZE	CUFF
E542 85251	X-Small	Green
E542 85261	Small	White
E542 85271	Medium	Red
E542 85281	Large	Blue
E542 85291	X-Large	Orange

GLOVE  
**\$10.95**



Extended Cuff



## Extended Cuff

#### Gray

ITEM NO.	SIZE	CUFF
E542 85301	X-Small	Green
E542 85311	Small	White
E542 85321	Medium	Red
E542 85331	Large	Blue
E542 85341	X-Large	Orange

#### White

ITEM NO.	SIZE	CUFF
E542 85351	X-Small	Green
E542 85361	Small	White
E542 85371	Medium	Red
E542 85381	Large	Blue
E542 85391	X-Large	Orange

GLOVE  
**\$11.95**

In the food processing industry **70% OF WORKERS** who suffered hand injuries were **NOT** wearing protective gloves.

Indirect costs can include  
**LOST WORKER PRODUCTIVITY**  
 (potentially running into the 10's of thousands of dollars), cost of training replacement employees, damage to workers' morale and **COMPANY REPUTATION.**



Standard Cuff

The average hand injury bill **EXCEEDS \$6,000**, with each workers' compensation claim reaching **\$7,500.**

**NOTE: These gloves are sold individually, NOT as a pair.**

**A6**



**Standard Cuff**

**Gray**

ITEM NO.	SIZE	CUFF
E542 85601	X-Small	Green
E542 85611	Small	White
E542 85621	Medium	Red
E542 85631	Large	Blue
E542 85641	X-Large	Orange
E542 06501	2X-Large	Gray

**White**

ITEM NO.	SIZE	CUFF
E542 85651	X-Small	Green
E542 85661	Small	White
E542 85671	Medium	Red
E542 85681	Large	Blue
E542 85691	X-Large	Orange

**GLOVE**  
**\$8.95**

**Extended Cuff**

**Gray**

ITEM NO.	SIZE	CUFF
E542 33001	X-Small	Green
E542 33011	Small	White
E542 33021	Medium	Red
E542 33031	Large	Blue
E542 33041	X-Large	Orange

**White**

ITEM NO.	SIZE	CUFF
E542 33101	X-Small	Green
E542 33111	Small	White
E542 33121	Medium	Red
E542 33131	Large	Blue
E542 33141	X-Large	Orange

**GLOVE**  
**\$10.95**

**A9**



**Standard Cuff**

**White Only**

ITEM NO.	SIZE	CUFF
E542 85751	X-Small	Green
E542 85761	Small	White
E542 85771	Medium	Red
E542 85781	Large	Blue
E542 85791	X-Large	Orange

**GLOVE**  
**\$14.95**

**A6**



**Standard Cuff**

**Gray**

ITEM NO.	SIZE	CUFF
E542 85401	X-Small	Green
E542 85411	Small	White
E542 85421	Medium	Red
E542 85431	Large	Blue
E542 85441	X-Large	Orange

**White**

ITEM NO.	SIZE	CUFF
E542 85451	X-Small	Green
E542 85461	Small	White
E542 85471	Medium	Red
E542 85481	Large	Blue
E542 85491	X-Large	Orange

**GLOVE**  
**\$10.95**

**Extended Cuff**

**Gray**

ITEM NO.	SIZE	CUFF
E542 85501	X-Small	Green
E542 85511	Small	White
E542 85521	Medium	Red
E542 85531	Large	Blue
E542 85541	X-Large	Orange

**White**

ITEM NO.	SIZE	CUFF
E542 85551	X-Small	Green
E542 85561	Small	White
E542 85571	Medium	Red
E542 85581	Large	Blue
E542 85591	X-Large	Orange

**GLOVE**  
**\$11.95**



Cut-Resistant Glove can be worn on knife hand, when a metal mesh glove is used.



Cut-Resistant Glove can be worn on non-knife hand, when a metal mesh glove is not used.



**WARNING:** These gloves are cut-resistant but not cut proof or puncture proof. Do not subject to moving or highly serrated blades.

# WorkHorse® Stainless Steel Metal Mesh Gloves with Strap Closure

The longest lasting, safest, most comfortable mesh glove — at the **LOWEST COST!**

- Heavy-gauge stainless steel rings are machine welded to give the longest lasting protection against cuts and lacerations.
- Ergonomically designed to give the best fit and dexterity.
- Available in full hand style with permanently attached straps, and extended 2-3 inch cuff designs with field-replaceable straps.
- Metal dome snap reduces donning and doffing time.
- Color-coded adjustable strap denotes size.
- Easy to clean and sanitize.

**NOTE: These gloves are sold individually, NOT as a pair.**



**GLOVE**  
**\$91.25**  
Double reinforced rings at stress points to extend glove life and eliminate repairs.

## A. Wrist-Length Cuff

ITEM NO.	SIZE	STRAP
E542 10001	X-Small, Size 6 . . . .	Gray
E542 10011	Small, Size 7 . . . . .	White
E542 10021	Medium, Size 8 . . . .	Red
E542 10031	Large, Size 9 . . . . .	Blue
E542 10041	X-Large, Size 10 . . .	Green
E542 06661	2X-Large, Size 11 . .	Brown

## B. 2-Inch Extended Wrist-Length Cuff

ITEM NO.	SIZE	STRAP
E542 02531	X-Small, Size 6 . . . .	Gray
E542 02541	Small, Size 7 . . . . .	White
E542 02601	Medium, Size 8 . . . .	Red
E542 02611	Large, Size 9 . . . . .	Blue
E542 02621	X-Large, Size 10 . . .	Green

**NOTE: We recommend wearing a cotton knit glove underneath your metal mesh.**

**GLOVE**  
**\$112.35**

## C. 3-Inch Extended-Length Cuff

ITEM NO.	SIZE	STRAP
E542 30001	X-Small, Size 6 . . . .	Gray
E542 30011	Small, Size 7 . . . . .	White
E542 30021	Medium, Size 8 . . . .	Red
E542 30031	Large, Size 9 . . . . .	Blue
E542 30041	X-Large, Size 10 . . .	Green

▶ **SEE PAGES 4 For Cotton Knit Gloves**

**GLOVE**  
**\$115.45**



Reversible design fits both left and right hand workers.

Permanently attached straps.

2-inch and 3-inch cuff with field replaceable straps. See [bunzlprocessor.com](http://bunzlprocessor.com) for more information.



PRICES ARE SUBJECT TO CHANGE • MINIMUMS MAY APPLY • VISIT OUR WEBSITE FOR CURRENT PRICING.

## Metal Mesh Glove Tensioner

Applies a force to maintain tension and gives gloves a snug fit.

- Sanitary, stretchable polymeric mesh glove tensioner.
- Fits over the mesh glove on the back of the hand.
- Color: blue. • One size fits most.



▶ 100 PER PACK.

ITEM NO.	COLOR	PACK
6235 01005	Blue . . . . .	<b>\$82.45</b>

## WorkHorse® Safety Glasses with Standard Anti-Fog



- Scratch-resistant coating.
- Metal-detectable hinge pins.
- 99.9% UV Protection.
- Meets ANSI Z87.1+, CE EN166 and CSA Z94.3 standards.



▶ 12 PER BOX - 25 BOXES PER CASE - 144 CASES PER PALLET.

ITEM NO.	PRODUCT	EACH
E542 09211	WorkHorse® Frameless Clear, Standard Anti-Fog . . . . .	<b>\$3.26</b>
E542 09221	WorkHorse® Frameless Blue, Standard Anti-Fog . . . . .	<b>3.26</b>

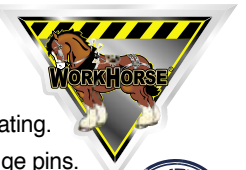

## WorkHorse® Tapered Disposable Earplugs

*NRR-33, highest NRR available in an earplug.*

- Tapered shape designed to fit most ear sizes.
- Constructed of expandable foam for a comfortable seal.
- Blue cords and orange earplugs are highly visible.
- Individually poly-bagged.



▶ 100 PAIR PER DISPENSER BOX - 10 BOXES PER CASE - 16 CASES PER PALLET.

ITEM NO.	PRODUCT	BOX
E542 09455	Tapered Disposable Earplugs	\$33.24



## WorkHorse® Bell-Shaped Disposable Earplugs

- Bell shape follows the natural contours of the ear canal.
- Constructed of expandable foam for a comfortable seal.
- Blue cords and orange earplugs are highly visible.
- Individually poly-bagged.



▶ 100 PAIR PER DISPENSER BOX - 10 BOXES PER CASE - 16 CASES PER PALLET.

ITEM NO.	PRODUCT	BOX
E542 09475	Bell-Shaped Disposable Earplugs	\$33.24



## WorkHorse® Reusable Earplugs

- Stem allows for easy insertion into ear.
- Four-flange design conforms to the ear for a comfortable fit.
- Blue cords and orange earplugs are highly visible.
- Individually poly-bagged.



▶ 100 PAIR PER DISPENSER BOX - 10 BOXES PER CASE - 16 CASES PER PALLET.

ITEM NO.	PRODUCT	BOX
E542 09775	Flanged Reusable Earplugs	\$87.54

## WorkHorse® Reusable Metal Detectable Earplugs

- Both earplugs and cords are metal detectable.
- Stem allows for easy insertion into ear.
- Blue cords and earplugs are highly visible.
- Four-flange design conforms to the ear for a comfortable fit.
- Individually poly-bagged.



▶ 100 PAIR PER DISPENSER BOX - 10 BOXES PER CASE - 16 CASES PER PALLET.

ITEM NO.	PRODUCT	BOX
E542 09765	Reusable, Flanged, Metal Detectable	\$105.44

## WorkHorse® Disposable Metal Detectable Earplugs

- Both earplugs and cords are metal detectable.
- Constructed of expandable foam for a comfortable seal.
- Blue cords and earplugs are highly visible.
- Individually poly-bagged.

▶ 100 PAIR PER DISPENSER BOX - 10 BOXES PER CASE - 16 CASES PER PALLET.

ITEM NO.	PRODUCT	BOX
E542 09465	A. Disposable, Tapered, Metal Detectable	\$42.94
E542 09485	B. Disposable, Bell-Shaped, Metal Detectable	42.94

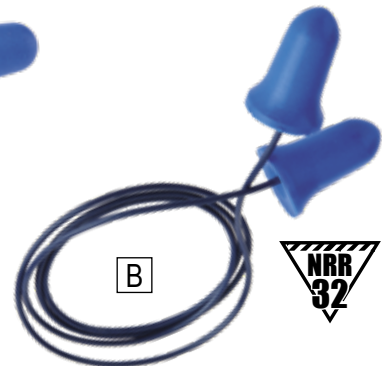
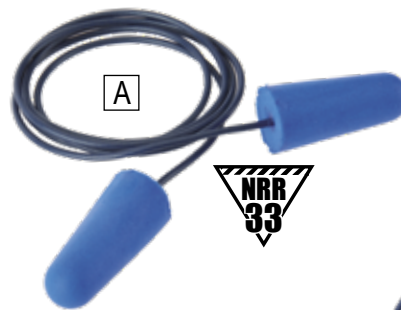

PRICES ARE SUBJECT TO CHANGE • MINIMUMS MAY APPLY • VISIT OUR WEBSITE FOR CURRENT PRICING.

# V-GARD® Safety Hard Hat

Light-weight and comfortable to wear all day.



- Injection molded of non-conductive high-density polyethylene.
- Meets requirements for Type 1, ANSI Z89.1-2014 and CSA Z94.1-2015 (Class E).
- Provides a minimum safety crown clearance of 1-1/4 inches between top of head and shell.



Slotted design for hard hat accessories



ITEM NO.	COLOR
3085 71271	White
3085 71291	Green
3085 71281	Blue
3085 71301	Yellow
3085 71311	Red
3085 71321	Orange
3085 71331	Gray
3085 48511	Gold
3085 11801	Tan
3085 31111	Light Blue
3085 11241	Burgundy
3085 53641	Pink w/Staz-On Suspension



Includes Staz-On Suspension.



Optional ratchet-style replacement suspension.

▶ 20 PER CASE.

EACH
<b>\$14.29</b>

ITEM NO.	PRODUCT	EACH
3085 79211	Replacement Staz-On Suspension . . . . .	<b>\$12.99</b>
3085 87081	Replacement Ratchet Suspension . . . . .	<b>20.73</b>

# V-GARD® Clear Visor

Attaches easily to V-GARD® hard hats by use of frame.



- Replaceable debris control creates a tight seal between helmet and frame.
- Frame and face shield visor sold separately.
- Frame required for visor to attach to V-GARD® hard hat.
- V-shaped alignment guides and three touch point load for easy installation.
- Sliding adjustment blades allow visor to work with most half-mask respirators.



▶ SEE ABOVE  
For V-GARD® Hard Hats,  
Sold Separately

ITEM NO.	PRODUCT	EACH
3085 850D1	V-GARD® Frame . . . . .	<b>\$22.82</b>
3085 355E1	Clear Visor. . . . .	<b>11.00</b>



# Marinades

- Blends formulated for use in vacuum tumblers or as a soak.
- Each makes 25 pounds of juicy product and adds no fat.
- All marinades are complete, including sodium phosphate.



## Cajun Style #120

Zesty blend with red, white and black pepper.

▶ 24 BAGS PER CASE.

ITEM NO.	PRODUCT	BAG
3030 00331	9.5 oz. #120. . . . .	<b>\$7.65</b>

## Lemon Pepper #121

Lemon and pepper in perfect proportions. Great for chicken and seafood.

ITEM NO.	PRODUCT	BAG
3030 00341	8.25 oz. #121. . . . .	<b>\$5.56</b>

## Lemon Butter #143

Especially pleasing with it's delicate flavor.

ITEM NO.	PRODUCT	BAG
3030 25571	8.75 oz. #143. . . . .	<b>\$6.55</b>

## Butter Garlic #144

Perfect proportions of butter and garlic. Great for beef and seafood.

ITEM NO.	PRODUCT	BAG
3030 03121	9.75 oz. #144. . . . .	<b>\$7.81</b>

## Greek #146

Spicy and colorful combination of pepper, garlic and herbs.

ITEM NO.	PRODUCT	BAG
3030 03151	9.25 oz. #146. . . . .	<b>\$6.55</b>

## New Orleans #166

A blend of herbs including rosemary, thyme and garlic.

ITEM NO.	PRODUCT	BAG
3030 01661	13.5 oz. #166. . . . .	<b>\$9.24</b>

## Garlic & Pepper Seasoning Flip-Top Gourmet Seasonings, 5.5 oz.

Perfect for retail – customers will love them!

ITEM NO.
3030 0057

▶ 12 PER CASE  
**\$57.20**



## Narrow Straight Boning Knives



**INOXPRO**  
CUTLERY



► 10 PER BOX.

ITEM NO.	SIZE	MFR. NO.	HANDLE	EACH	
				1-5	6+
E542 06261	A. 5"	IPNSB5F-MH	MH, Black	\$25.84	\$19.42
E542 06291	B. 5"	IPNSB5S-MH	MH, Black	25.84	19.42
E542 06231	C. 6"	IPNSB6F-MH	MH, Black	27.02	20.60
E542 06171	D. 6"	IPNSB6-MFMH	MH, Black	27.02	20.60

## Curved Boning Knives



► 10 PER BOX.

ITEM NO.	SIZE	MFR. NO.	HANDLE	EACH	
				1-5	6+
E542 06301	A. 5"	IPCB5F-MH	MH, Black	\$24.66	\$18.24
E542 09751	5"	IPCB5F-MH	MH, Blue	24.15	18.15
E542 06251	5"	IPCB5S-MH	MH, Black	24.66	18.24
E542 06671	B. 6"	IPCB6F-MH	MH, Black	27.02	20.60
E542 09511	6"	IPCB6F-MHG	MH, Green	27.75	21.43
E542 06481	C. 6"	IPCB6S-MH	MH, Black	27.02	20.60
E542 13251	D. 6"	IPCB6FBT-MH	MH, Black, Blunt Tip	24.56	18.73
E542 08781	E. 5"	IPCB5F-MRS	MRS, Black w/Yellow	27.02	20.60
E542 08791	F. 6"	IPCB6F-MRS	MRS, Black w/Red	28.19	21.77
E542 08801	6"	IPCB6S-MRS	MRS, Black w/Blue	29.37	22.95

## Steels

**INOXPRO**  
CUTLERY



### A. Polished Steel

Corrosion-resistant tapered shaft. ► 6 PER BOX.

ITEM NO.	PRODUCT	MFR. NO.	EACH
E542 09101	10" Polished. . . . .	5325-2561P . . . . .	\$30.75

### B. Sharpening Steels

Molded plastic handle with guard and ring. ► 6 PER BOX.

ITEM NO.	PRODUCT	MFR. NO.	EACH
E542 09121	A. 10" Regular Cut. . . . .	5210-2501P . . . . .	\$28.75
E542 09091	B. 10" Fine Cut. . . . .	5210-2551P . . . . .	28.75

### C. Trimmer Steels

White nylon handle with guard and ring. ► 6 PER BOX.

ITEM NO.	PRODUCT	MFR. NO.	EACH
E542 09111	5" . . . . .	5215-1501P . . . . .	\$14.50
E542 08821	7-1/2" . . . . .	5215-2001P . . . . .	17.50

INOX PRO® steels are crafted in Germany.

PRICES ARE SUBJECT TO CHANGE • MINIMUMS MAY APPLY • VISIT OUR WEBSITE FOR CURRENT PRICING.

# Oyster Knives

- SuperGrip handle prevents slipping.
- New Haven knife has a hooked tip to help pry open shells.
- Boston knives have round tip for extra leverage.
- Galveston knife has a broad straight-edged blade.



**VICTORINOX**  
SWISS ARMY



▶ 6 PER BOX.

ITEM NO.	PRODUCT	MFR. NO.	EACH	
			1-5	6+
3367 46921	A. Providence, 2-3/4" Blade . . .	7.6399.2 . . .	\$17.34	\$15.30
3367 46931	B. New Haven, 2-3/4" Blade . . .	7.6399.3 . . .	17.34	15.30
3367 46941	C. Boston, 3" Blade . . . . .	7.6399.4 . . .	17.34	15.30
3367 46961	D. Boston, 4" Blade, Narrow . . .	7.6399.6 . . .	18.28	16.07
3367 46951	E. Galveston, 4" Blade. . . . .	7.6399.5 . . .	18.28	16.07

# Fibrox® Pro Breaking Knives



▶ 6 PER BOX.

ITEM NO.	PRODUCT	MFR. NO.	EACH	
			1-5	6+
3367 05371	8" Curved . . . . .	40537 . . . . .	\$45.80	\$40.28
3367 05381	10" Curved . . . . .	40538 . . . . .	52.58	45.67

# Fibrox® Pro Fillet Knife, 6 Inch



▶ 6 PER BOX.

ITEM NO.	PRODUCT	MFR. NO.	EACH	
			1-5	6+
3367 07141	6" Straight . . . . .	40714 . . . . .	\$28.32	\$22.85

# Dexter® Sani-Safe® Seafood Knives

A textured, slip-resistant, easy-to-clean polypropylene handle withstands both high and low temperatures.



## Sliming Knife



▶ 6 PER BOX.

ITEM NO.	PRODUCT	MFR. NO.	EACH	
			1-5	6+
5816 13381	4-1/2" Blade . . . . .	S125 . . . . .	\$26.92	\$25.67

## Gut Knife with Spoon



▶ 6 PER BOX.

ITEM NO.	PRODUCT	MFR. NO.	F.O.B. FACTORY EACH	
			1-5	6+
5816 01471	A. 4-1/2" Blade . . . . .	S133-4CP . . . . .	\$26.88	\$25.63
5816 01761	B. 6" Blade . . . . .	S133-6CP . . . . .	26.88	25.63

## Clam Knife



▶ 12 PER BOX.

ITEM NO.	PRODUCT	MFR. NO.	EACH	
			1-11	12+
5816 04431	A. 3" Blade, 6" Overall . . . . .	S127 . . . . .	\$13.81	\$9.99
5816 00281	B. 3-2/5" Blade, 7-2/5" Overall . . .	S129 . . . . .	14.85	11.07

## Catfish Boning Knife

- Yellow, sure grip textured handle.
- Protective finger guard.
- Proprietary DEXSTEEL blade.



▶ 6 PER BOX.

ITEM NO.	PRODUCT	MFR. NO.	EACH	
			1-5	6+
5816 03131	6" Narrow, Curved Flex . . .	C131F-6 . . . . .	\$26.67	\$19.52

PRICES ARE SUBJECT TO CHANGE • MINIMUMS MAY APPLY • VISIT OUR WEBSITE FOR CURRENT PRICING.



## Filleting Knives



► 10 PER BOX.

ITEM NO.	SIZE	MFR. NO.	HANDLE	BLADE	EACH	
					1-9	10+
6818 00411	A. 7"	9180P	P Grip	Flex	\$19.30	\$17.84
6818 00211	B. 7" Narr.	9174P	P Grip	Flex	19.66	15.69
6818 00361	C. 8"	9197UG	UG Grip	Flex	21.58	18.05
6818 00381	8"	9218UG	UG Grip	Med-Flex	22.52	15.20
6818 00331	D. 8"	9197PG	Pro Grip	Flex	20.50	16.92
6818 00371	8" Narr.	9218PG	Pro Grip	Flex	23.16	19.45
6818 00281	E. 8" Wide	9210P	P Grip	Med-Flex	21.30	18.22

## Straight Wide Boning Knives



► 10 PER BOX.

ITEM NO.	SIZE	MFR. NO.	HANDLE	BLADE	EACH	
					1-9	10+
6818 00251	A. 6"	9153PG	Pro Grip	Stiff	\$18.50	\$18.20
6818 00241	B. 6"	9153P	P Grip	Stiff	15.40	15.02

## Gutting and Cleaning Knives



► 10 PER BOX.

ITEM NO.	SIZE	MFR. NO.	HANDLE	BLADE	EACH	
					1-9	10+
6818 00191	5"	299P	P Grip	Stiff	\$22.48	\$18.73
6818 00171	6"	9152P	P Grip	Stiff	22.48	18.73
6818 00201	7"	1040S	P Grip	Stiff	22.48	18.73

### FROST FLEX INDEX

Carefully selected steel enables knives to be sharpened to an extreme edge and sharpness that lasts.



## Butcher/Trimming Knives



► 10 PER BOX.

ITEM NO.	SIZE	MFR. NO.	HANDLE	BLADE	EACH	
					1-9	10+
6818 00351	A. 6"	9150	PS Grip	Med-Flex	\$17.76	\$17.42
6818 00271	B. 6"	9150PS	PS Grip	Med-Flex	18.64	15.70
6818 00401	C. 10"	7253UG	UG Grip	Stiff	49.08	41.35

## Chefs Knives



► 10 PER BOX.

ITEM NO.	SIZE	MFR. NO.	HANDLE	EACH	
				1-9	10+
6818 00231	A. 7"	4171PG	Pro Grip	\$31.20	\$25.95
6818 00221	B. 9"	4216PG	P Grip	37.44	35.73
6818 00181	C. 10-1/2"	4261UG	UG Grip	19.31	16.05

## FROSTS SEAFOOD KNIFE HANDLES

Handles Made of Polypropylene

P	Pro G	UG Grip	PS Grip
Glass Fiber Reinforced Polypropylene — rough, durable grip.	Molded Textured Rubber — enhanced non-slip grip.	Hard Polyamide — soft feel, wear- and oil/fat-resistant.	Smaller Size of the P-Grip Handle.

Blades made of recycled Swedish stainless steel knife. Recommended for seafood processing.

PRICES ARE SUBJECT TO CHANGE • MINIMUMS MAY APPLY • VISIT OUR WEBSITE FOR CURRENT PRICING.

# IM313 Multi Oilstone Set

Ideal for general sharpening and honing large straight edge knives and tools.

- Non-skid base serves as an oil reservoir in which stones may be immersed when not in use.

Set includes:

Oilstone Holder Base	Coarse-grit Crystolon®
Dust Cover	Medium-grit Crystolon®
Pint of Mineral Oil	Fine-grit India Stone

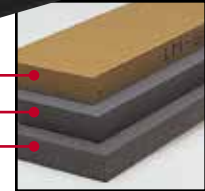

ITEM NO.	PRODUCT	DIMENSIONS	EACH
4808 0313	Multi Oilstone Sharpener Set		\$345.34
4808 10031	Coarse Grit Replacement Stone	11-1/2" x 2-1/2" x 1/2"	57.30
4808 10061	Medium Grit Replacement Stone	11-1/2" x 2-1/2" x 1/2"	57.30
4808 00091	Fine Grit Replacement Stone	11-1/2" x 2-1/2" x 1/2"	57.30
4808 10021	Mineral Oil, 1 qt.		29.83

# Specialty Blades

- Single bevel (SB) • Double bevel (DB)



ITEM NO.	PRODUCT	DESCRIPTION	REPLACEMENT FOR OEM*	OEM NO.*	LENGTH	WIDTH	THICKNESS	CUTTING EDGE	MOUNT HOLES
F187 22091		Piercing Blade	CRYOVAC®	FUR-58463	45.6 mm	10.3 mm	0.80 mm	45° w/pt	1
F186 00011		Narrow Cut Blade	CRYOVAC®	PE20S074	345 mm	15 mm	1.2 mm	SB	0
F187 22111		Packaging Cutoff Blade	CRYOVAC®	2070A-8550	385 mm	19 mm	1.3 mm	Serrated	Yes
F187 22131		0.080" Standard Packaging Cutoff Blade	CRYOVAC®	PV01S004 FUR82607	414 mm	46.25 mm	0.080" STD	Serrated	2
F187 22121		0.125" Heavy Duty Packaging Cutoff Blade	CRYOVAC®	PV01S004 THICK VERSION	414 mm	45.25 mm	1.25 HD	Serrated	Yes
F187 22151		Packaging Cutoff Blade	CRYOVAC®	PV01S005	514 mm	35 mm	0.50 mm	Serrated	Yes
F187 15351		Packaging Cutoff Blade	CRYOVAC®	PV23S001	570.2 mm	50.5 mm	0.80 mm	Serrated	2
E542 14521		Packaging Shear Blade	CRYOVAC®	PV02S002	526 mm	46.25 mm	1.25 mm	Serrated	Yes
F187 24011		Tape Blade	3M™	78-8017-9173-8	2.56"	1.1"	1.5 mm	Serrated	3 Slots
F187 21881		Tape Blade	DEKKA	06-015	60 mm	24.5 mm	1.6 mm	Serrated	2 Slots
F264 26401		Tape Blade	LITTLE DAVID	PCS11B4	62 mm	25 mm	0.50 mm	Serrated	3 Holes
L228 00041		2pc SS Slitter Blade DB	MULTIVAC	79.915.2009.41	90 mm	42 mm	0.2 mm	DB	3/Blade
F187 09421		2pc SS Slitter Blade DB	MULTIVAC	79.915.2009.42	90 mm	42 mm	2 mm	Single	3/Blade
F264 04051		Cutoff Blade	MULTIVAC		405 mm	40 mm	1 mm	DB Scalloped	2, no notches

PRICES ARE SUBJECT TO CHANGE • MINIMUMS MAY APPLY • VISIT OUR WEBSITE FOR CURRENT PRICING.

## Hyde FC Revolution Circular Blades

They provide fish processing plants with a superior cut quality, less scrap, and lowered operating costs.

- Enhanced corrosion resistance, even in the toughest of cutting environments.
- Designed for both fresh and salt water processing.
- Will outperform and outlast the competition.
- Tensioned to run true for better quality cuts and less potential for waste.

**Call 800-456-5624**

*For More Information and Pricing*



**BLADES**

## Tray Pack Blades for All Tray Pack Machines

Short lead times and high quality products at affordable prices.

- Single- and multi-lane tray pack blades are manufactured to the highest industry standards.
- Customize to suit unique shape and form requirements.
- Razor sharp tooth profile ensures quality cuts in even the most demanding of food packaging applications.

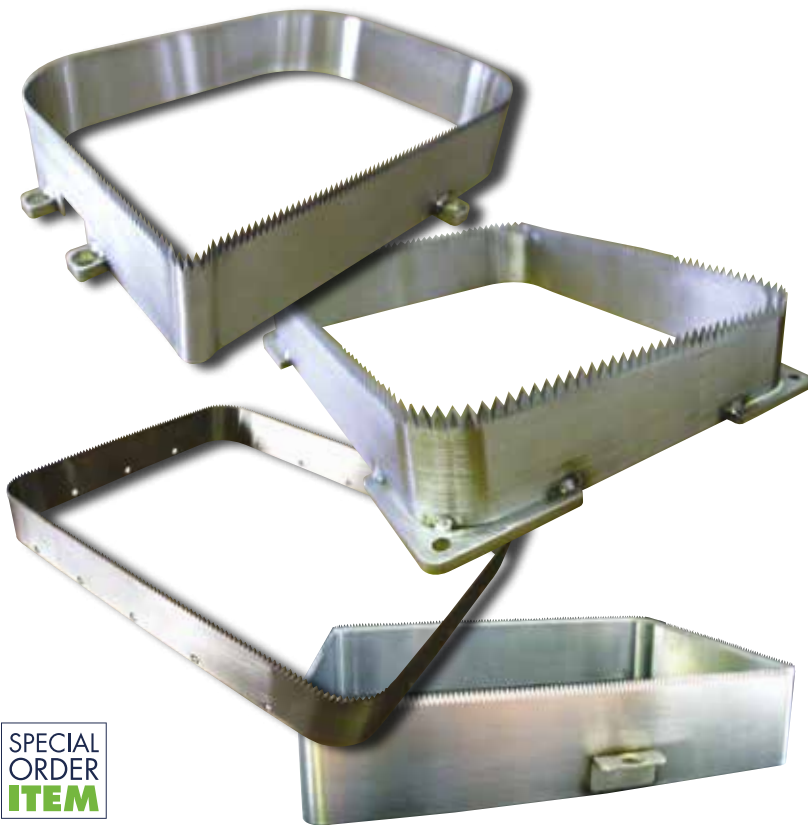

**SPECIAL  
ORDER  
ITEM**

**REPLACEMENT\* FOR ALL OF THE MAJOR OEM'S  
IN THE MODIFIED ATMOSPHERE  
PACKAGING MACHINE SECTOR, SUCH AS:**



**AND MANY MORE!**

**Call 800-456-5624**  
*For More Information and Pricing*

\*All parts are manufactured for BUNZL Processor Division and are not made, licensed, sponsored or approved by the original equipment manufacturer. All products listed are replacement parts only; they are not an original equipment part of the manufacturers listed and BUNZL Processor Division is not affiliated with the manufacturers listed. All references to original manufacturer's equipment are for identification purposes only. All BUNZL parts are manufactured to exacting specifications using the highest quality materials.

PRICES ARE SUBJECT TO CHANGE • MINIMUMS MAY APPLY • VISIT OUR WEBSITE FOR CURRENT PRICING.

# Blades



Our optimized material treatment will ensure a longer blade lifetime, which will lead to minimum downtime, less maintenance, a maximized yield and a clean and uniform final result.



ITEM	PRODUCT	DESCRIPTION	LENGTH	AVAILABLE DIMENSIONS (MM)
Munkfors Band Knife - Smooth		This single or double-beveled band knife is a versatile knife that can be used in several working materials.	Any	12.5 mm x 0.5 mm 16 mm x 0.5 mm 20 mm x 0.5 mm 20 mm x 0.7 mm
Munkfors Sharp Concave		Our wavy concave blade is suitable for a large variety of working materials such as fish, sausage, vegetables and cheese.	Any	12.5 mm x 0.5 mm 16 mm x 0.5 mm 20 mm x 0.2 mm
Munkfors 3 TPI		This blade is the standard choice when cutting frozen fish blocks, patties and frozen fish of all kinds. The blade has three teeth per inch (3TPI). *Available as corrosion resistant.	Any	16 mm x 0.36 mm 16 mm x 0.40 mm 16 mm x 0.50 mm 16 mm x 0.56 mm* 20 mm x 0.50 mm* 25 mm x 0.60 mm
Munkfors 2 TPI		This blade is advantageous to use when the fish is extra deep frozen and when you process large fish blocks and large fish such as tuna, marlin and swordfish. The blade has two teeth per inch (2TPI).	Any	25 mm x 0.60 mm 35 mm x 0.80 mm
Munkfors SPS 10		Our Munkfors SPS 10, which stands for Munkfors Surprise with a tooth size of 10 mm. The blade has a small tooth between the big teeth, which works as a cleaning tooth by preventing the accumulation of debris in the cutting area and in general reduces noise-levels.	Any	16 mm x 0.50 mm

**Call 800-456-5624 For More Information and Pricing**

# HPS-1 Non-Penetrating Air-Powered Stunner

Unique design euthanizes fish up to 30 pounds, rendering them insensible to pain.

- Practical for use on small pigs, turkeys, rabbits, geese, alligators and fish.
- Can be used with either an easily changeable 12-ounce CO<sub>2</sub> cylinder (providing over 150 shots), portable high-pressure air tank or connected to an air compressor.
- Adjustable impact pressure handles different sizes of animals.
- Single trigger control makes for comfortable handling and operation.
- Light-weight, easy-to-clean and repair.

**JARVIS**

MADE IN USA



ITEM NO.	PRODUCT	JARVIS NO.	EACH
3028 43171	HPS-1 Stunner . . . . .	4044131. . . . .	<b>CALL FOR PRICING</b>

**SHOP 24/7**  
[bunzlprocessor.com](http://bunzlprocessor.com)

**Need Help?**  
Chat With Us Online!

**CHAT**

STAY CONNECTED WITH US:

[f](#) [X](#) [v](#) [in](#) [p](#) [i](#)

Where you can find out what's on sale, find updated product information, reviews and pricing.



How to operate.

Scan these QR codes with your mobile device to watch videos about the HPS-1 Stunner.



Disassembly and Reassembly

# 3 Mil Standard Vacuum Pouches

The **FACTS** behind our pouches:

- FDA approved for food contact.
- Contains NO BPA or melamine.
- Contains NO starches or animal by-products.
- Easy to open when filling. • Crystal clear with a glossy finish.
- Made from cast co-extruded film, more flexible and form fitting with an aggressive sealant.

**NOTE: These vacuum pouches are only for use in vacuum chamber machines.**



**PACKAGING**

ITEM NO.	SIZE IN INCHES	POUCHES PER BOX	BOX
7500 1815	6 x 8	1000	\$32.68
7500 1817	6 x 10	1000	40.88
7500 1818	6 x 12	1000	49.04
7500 1820	6 x 20	1000	81.68
7500 1826	7 x 11	1000	52.41
7500 1829	8 x 10	1000	54.48
7500 1830	8 x 12	1000	65.34
7500 1831	8 x 15	1000	81.68
7500 1836	10 x 10	1000	68.07
7500 1838	10 x 13	1000	88.51

ITEM NO.	SIZE IN INCHES	POUCHES PER BOX	BOX
7500 1839	10 x 15	1000	\$102.12
7500 1840	10 x 18	500	61.27
7500 1842	10 x 22	500	74.89
7500 1854	12 x 16	500	65.34
7500 1856	12 x 22	500	89.85
7500 1861	14 x 16	500	76.26
7500 1866	16 x 16	500	87.12
7500 1867	16 x 20	500	108.93
7500 1875	18 x 28	250	85.78
7500 1879	20 x 28	250	95.30

# 3 Mil Gold Metallic Vacuum Pouches

Distinctive packaging to enhance your products visibility!

- Metallic design on back panel with a clear front panel.
- Differentiate yourself from the competition.

**NOTE: These vacuum pouches are only for use in vacuum chamber machines.**



ITEM NO.	SIZE IN INCHES	POUCHES PER BOX	BOX
7500 1991	4 x 9	500	\$38.37
7500 1992	6 x 8	500	52.70
7500 1996	8 x 10	500	83.28
7500 1997	8 x 12	500	91.44
7500 1999	10 x 15	500	152.62

# 10K OTR Fresh Fish Non-Barrier Bags

HP2700

- Good for fresh seafood: tuna loins, mahi, sea bass fillets, bulk fillets such as salmon, catfish, cod, flounder and tilapia.
- Standard gauge. • Untaped bags. • Color: clear.
- Preprinted with "Cryovac 10K OTR" information.



# CLARITY

FLEXIBLE PACKAGING

**CRYOVAC**  
Sealed Air

Case Pack				
ITEM NO.	SIZE	SEAL	QTY./CASE	CASE
1800 2199	8 x 12	SE	2500	\$703.32
1800 2203	13 x 19	SE	1250	876.67
1800 2872	14 x 24	CE	750	666.38
7584 0524	11 x 25	SE	500	368.28
7584 0525	11 x 30	SE	500	428.82

Smart Pack				
ITEM NO.	SIZE	QTY./BOX	BOX	
7584 3488	8 x 12	250	\$77.80	
7584 3490	13 x 19	250	167.55	
7584 3500	14 x 24	250	212.30	
7584 1263	10 x 25	SE	193.12	
7584 1262	11 x 30	SE	223.35	



PRICES ARE SUBJECT TO CHANGE • MINIMUMS MAY APPLY • VISIT OUR WEBSITE FOR CURRENT PRICING.

## Locker Paper

- FDA approved for direct food handling.
- Consistent polyethylene coating helps lock in moisture.
- Prevents freezer burn.
- Retains strength when wet.
- Core: 3 inches.



## Light Weight

Locks out freezer burn up to 6 months.

ITEM NO.	PRODUCT	ROLL	
		1-19	20+
3053 02701	15" x 1,100 ft.	\$54.06	\$49.06
3053 02711	18" x 1,100 ft.	66.06	61.06
3053 02761	24" x 1,100 ft.	87.08	82.08

## Medium Weight

Locks out freezer burn up to 9 months.

ITEM NO.	PRODUCT	ROLL	
		1-19	20+
3053 02721	15" x 1,100 ft.	\$61.74	\$56.74
3053 02731	18" x 1,100 ft.	74.08	69.08
3053 02741	24" x 1,100 ft.	98.76	93.76

## Heavy Weight

Locks out freezer burn up to 12 months.

ITEM NO.	PRODUCT	ROLL	
		1-19	20+
3053 02661	15" x 1,000 ft.	\$69.60	\$64.60
3053 02751	18" x 1,000 ft.	83.52	78.52

## DYKEM® SAFE-MARK NSF Certified General Purpose Markers

- General purpose, quick-drying permanent ink marker.
- Marks withstand temperatures spanning -20 °F to 475 °F.
- "Locked nib" prevents tip from falling out and into processing operations.
- Valve action mechanism prevents barrel ink from drying when cap is left off.
- Ideal for any surface: metal, glass, plastic, cardboard, rubber, shrink film, stretch wrap, etc.



► 12 PER BOX.

ITEM NO.	PRODUCT	EACH
3112 09071	Black	\$6.59

## Scotch® High Tack Box Sealing Tape 311+

- High performance, high tack industrial packaging tape designed for cold and damp temperatures.
- Great for box sealing, splicing, recoupage and demanding packaging applications.
- Excellent performance over broad temperature ranges, even below freezing.
- Quick and easy application by hand, manual dispensers or 3M-Matic™ Case Sealers.
- Adheres to highly recycled corrugated boxes. • Available in 48 mm and 72 mm widths.
- Core diameter: 3 inches.

**NOTE: Can be applied at cold temperatures of 20-50 °F and performs at temperatures below 32 °F.**



### Hand Size Rolls

ITEM NO.	PRODUCT	QTY.	EACH
6655 38281	48 mm x 100 m	36 Rolls/Case	\$4.51
6655 38781	72 mm x 100 m	24 Rolls/Case	\$4.96
ITEM NO.	PRODUCT	EACH	
H350 00021	Tape Dispenser		\$12.49

### Machine Size Rolls

ITEM NO.	PRODUCT	QTY.	CASE
6655 3830	48 mm x 914 m	.6 Rolls/Case	\$197.35
6655 3831	48 mm x 1,500 m	.6 Rolls/Case	282.21
6655 3638	72 mm x 914 m	.4 Rolls/Case	203.04
6655 4826	72 mm x 1,500 m	.4 Rolls/Case	569.89

# Stainless Steel Washdown Scales

Washdown when powered by batteries.

- Removable 9-inch x 7-1/2-inch platform for easy washdown.
- Digital LCD readout displays 1-inch numerals and also features auto shutoff and push button tare, zero reset and low battery indicator.
- Class III rated.
- Scales weigh in pound/decimal pound and gram/kilogram.
- Shipping Weight: 8 pounds. • Six D batteries required, sold separately. ➔



SCALES

NOTE: AC adapter sold separately.



## -LEGAL FOR TRADE-

ITEM NO.	MODEL	POUNDS (lb) CAPACITY/ RESOLUTION	GRAMS (g) CAPACITY/ RESOLUTION	EACH
3416 1001	SK-1000WP	2.2 lb/0.001 lb	1,000 g/0.5 g	\$469.45
3416 2002	SK-2000WP	4.4 lb/0.002 lb	2,000 g/1 g	469.45
3416 5002	SK-5000WP	11 lb/0.005 lb	5,000 g/2 g	469.45
3416 0011	SK-10KWP	22 lb/0.01 lb	10 kg/0.005 kg	469.45
3416 0021	SK-20KWP	44 lb/0.02 lb	20 kg/0.01 kg	469.45
3416 00041	Optional Adapter			63.91

# Stainless Steel Washdown Bench Scale

Stainless steel washdown construction is dust- and water-resistant.

- IP65 rated washdown construction with stainless steel pan.
- Resolution can be changed automatically for three capacity levels.
- Triple weighing range function.
- Set your own high and low weight targets.
- LED comparator traffic lights.
- Accumulation and counting functions.
- Tiltable display with 10-digit keypad and memory storage.
- Change the weighing units and mode with the press of a button.
- A/C main (100 to 240V).



LCD display with white backlight.



LED comparator lights.

Alphanumeric keypad.

## -LEGAL FOR TRADE-

ITEM NO.	MODEL	CAPACITY	RESOLUTION	PLATFORM	SHIP WT.	F.O.B. FACTORY EACH
3416 1060	HV-60KC-WP	150 lb.	0.05 lb	13" x 16-7/10"	26 lb.	\$2,461.66
3416 1200	HV-200KC-WP	500 lb.	0.2 lb	15-2/5" x 20-9/10"	42 lb.	2,167.66

# OVER 10,000 ADDITIONAL PRODUCTS AVAILABLE!



Our experienced customer service representatives are available to answer your questions, find the products you are looking for, check product availability, as well as take your order.

**800-456-5624**

**SHOP 24/7**

Where you can find out what's on sale, find updated product information, reviews and pricing.



**bunzlprocessor.com**

PRICES ARE SUBJECT TO CHANGE • MINIMUMS MAY APPLY • VISIT OUR WEBSITE FOR CURRENT PRICING.



**CHECK OUT THE  
SEAFOOD SECTOR  
ON OUR NEW WEBSITE**

**BUNZLPROCESSOR.COM**

Our inventory includes over 35,000 ready-to-ship products from 14 distribution centers serving Central and North America, including the Caribbean and Mexico.

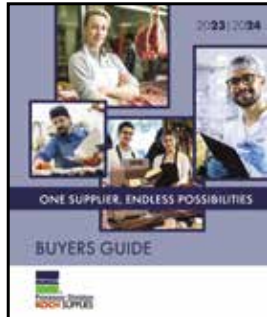

Over 8,000 plant operating supplies available in our *Buyers Guide*.

**FREE\* SHIPPING**  
on orders of \$500 or more  
Some Restrictions Apply



SCAN THE QR WITH YOUR MOBILE DEVICE TO VIEW OUR COMPLETE **BUYERS GUIDE**

**STAY CONNECTED WITH US:**



**Need Help?  
Chat With Us  
Online!**



**DISTRIBUTION CENTERS**

**ARKANSAS ■ SPRINGDALE**

**CALIFORNIA ■ FRESNO**

**COLORADO ■ DENVER**

**GEORGIA ■ ATLANTA**

**IOWA ■ ELDRIDGE**

**KANSAS ■ LIBERAL**

**MINNESOTA ■ AUSTIN**

**MISSOURI ■ KANSAS CITY**

**NORTH CAROLINA ■ LUMBERTON**

**NEBRASKA ■ OMAHA**

**OHIO ■ FAIRFIELD**

**PENNSYLVANIA ■ YORK**

**TEXAS ■ DALLAS**

**WASHINGTON ■ SPOKANE**

Source Code: **SF25**

**800-456-5624 • bunzlprocessor.com**