



BUNZL
Processor Division
KOCH SUPPLIES



DAIRY CATALOG 2026
800-456-5624 • BunzlProcessor.com



BUNZL PROCESSOR DIVISION

YOUR PREMIER PARTNER FOR FOOD PROCESSING AND EQUIPMENT



Bunzl Processor Division is a leading supplier of the food processing industry. The acquisition of Koch Supplies, Packers Engineering and Equipment and Enterprise allowed us to combine and expand our product offerings, warehousing, distribution expertise and buying power – giving our customers a high level of quality and service. We provide an unparalleled ability to service national platforms; as well as multi-plant, single-plant, small shops and game processors.

A Renowned History

Koch Supplies is one of the oldest businesses in Kansas City, establishing its roots as Koch Butcher Supply Company over 140 years ago. In fact, the grandchildren of people who did business with Koch Supplies during the World War II era are now running many of their family's businesses and are some of our best customers. Many of the associates at Bunzl Processor Division/Koch Supplies have tenure of over 20 years, with their relatives and children working alongside them.



In 2001, Koch Supplies became a proud part of Bunzl Processor Division – a leader in the food processing and food packaging industries. Bunzl Processor Division offers more than 35,000 different supply items and 14 distribution centers serving Central and North America, including the Caribbean and Mexico. But even though we have grown in size and scope, we continue the tradition of outstanding customer service that our customers have come to expect of us over the years, while ever expanding our product lines to fit our customers' needs.



Why Buy From Bunzl Processor Division?

- Dedicated exclusively to food processors
- 14 distribution centers
- Award-winning service
- Inside and outside sales and support
- Over 140 years in the industry
- Free UPS ground shipping on orders over \$500
- Small orders – no problem
- Large orders – big savings

YOU CAN FIND MORE PRODUCTS AND CURRENT PRICING ON OUR WEBSITE:

[BunzlProcessor.com](https://www.bunzlprocessor.com)



Need Help?
Chat With Us
Online!

STAY CONNECTED WITH US:



TRACKING



SECURE
PAYMENT



FAQ



PRICES ARE SUBJECT TO CHANGE • MINIMUMS MAY APPLY • VISIT OUR WEBSITE FOR CURRENT PRICING.

PUROFORT®



FoodPro Steel Toe Boots

35% lighter than traditional rubber and PVC boots!

- Resistant to mineral, animal and vegetable oil, fats, blood, disinfectants and various chemicals.
- Complies with CSA Z195-14 Omega, ASTM F2413-18 M/IC EH.
- Highest slip resistant sole of any boot. Certified slip resistance (EN ISO 20345:2011 S4 CI SRC).
- Steel toe cap for added safety.
- Remains flexible at low temperatures.
- Shock-absorbing heel.
- Sole designed for specific food processing areas.
- Several colors to reduce cross-contamination.
- 14-inch upper.
- Thermal insulation keeps feet warm in temperatures as low as -4 °F and comfortable in hot conditions.



PUROFORT® is the unique Dunlop® material with millions of evenly distributed air pockets making it light-weight and thermally insulating plus a cross-linked structure that provides flexibility and strength. The material is created using a special recipe at the time of manufacture, giving your Purofort® boots a "born on" date. This gives Purofort® boots their remarkable properties.

Multi-grip Safety Sole: SRC rated for best slip resistance.

Seamed anti-bacterial lining.

Scan this QR code with your mobile device to watch a video about Purofort® Boots.

Unique feature allows boots to be locked together. (Separate lock required.)



White

ITEM NO.	MEN'S SIZE
E014 00391	Size 3
E014 00401	Size 4
E014 00411	Size 5
E014 00421	Size 6
E014 00431	Size 7
E014 00441	Size 8
E014 00451	Size 9
E014 00461	Size 10
E014 00471	Size 11
E014 00481	Size 12
E014 00491	Size 13
E014 00501	Size 14
E014 00511	Size 15

Brown

ITEM NO.	MEN'S SIZE
E014 01371	Size 3
E014 00801	Size 4
E014 00811	Size 5
E014 00821	Size 6
E014 00831	Size 7
E014 00841	Size 8
E014 00851	Size 9
E014 00861	Size 10
E014 00871	Size 11
E014 00881	Size 12
E014 00891	Size 13
E014 00901	Size 14
E014 00911	Size 15

F.O.B. FACTORY

SOLD BY PAIR

ADDITIONAL BOOTS ARE AVAILABLE. SEE YOUR BUYERS GUIDE OR BUNZLPROCESSOR.COM FOR DETAILS.

PRICES ARE SUBJECT TO CHANGE • MINIMUMS MAY APPLY • VISIT OUR WEBSITE FOR CURRENT PRICING.



Boot Saver® Disposable Covers

TINGLEY

Prevent contamination with liquid proof disposable covers.

- 100% liquid proof protection for boots and shoes.
- Powder-free finish eliminates concerns about powder contamination on clothing, footwear, foods and food-contact surfaces.
- High quality, natural rubber latex stretches easily over boots while remaining resistant to snags, tears and abrasion.
- Ambidextrous — each cover fits both right and left feet.

SPECIAL ORDER ITEM

NOTE: Textured outsole provides grip on both wet and dry surfaces.

WARNING:
This Product Contains Natural Rubber Latex Which May Cause Allergic Reactions.

ITEM NO.	SIZE
4059 0328	Medium (7-9)
4059 0329	Large (9-11)
4059 0330	X-Large (11-14)
4059 0331	2X-Large (15+)

SOLD BY
CASE OF 100 PAIR

ADDITIONAL COLORS ARE AVAILABLE. SEE YOUR BUYERS GUIDE OR BUNZLPROCESSOR.COM FOR DETAILS.

ShuBee® Waterproof Shoe Covers

- One size fits all design comfortably accommodates work boots and other large footwear up to size 18.
- The waterproof material keeps moisture out, protecting floors from mud, rain, snow and other elements.
- The textured plastic sole provides excellent traction on various surfaces.



ITEM NO.	SIZE
C087 0001	One Size Fits All

SOLD BY
CASE OF 120

PRICES ARE SUBJECT TO CHANGE • MINIMUMS MAY APPLY • VISIT OUR WEBSITE FOR CURRENT PRICING.

WorkHorse® Knit Gloves

Natural with white cuff edge.

- Poly/cotton blend knitted gloves.
- Bleached and unbleached with sewn wrist bands.
- Color-coded cuff edges designates glove weight.
- Ambidextrous and machine washable.
- One size fits all.



BUNZL EXCLUSIVE
PROCESSOR DIVISION



ITEM NO.	PRODUCT	SOLD BY
E542 0372	Light-Weight Glove	CASE OF 40 DOZEN PAIR

WorkHorse® Standard 1 Mil Polyethylene Disposable Sleeves

- Low-cost waterproof protection for light-duty, limited-use applications.

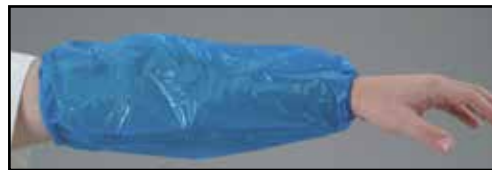

BUNZL EXCLUSIVE
PROCESSOR DIVISION



ITEM NO.	SIZE	COLOR	SOLD BY
E542 0501	16"	Blue	CASE OF 2,000
E542 0499	16"	White	
E542 0496	18"	Blue	
E542 0500	18"	White	

Work Force, Inc. Shoulder Length Polyethylene Gloves with Elastic Top

- Low density. • 1.5 mil. • Smooth finish.
- 34 inch long for shoulder-length protection.
- .04 mm thick. • Elastic top.

Sold by case of 1,000, 10 boxes of 100.

ITEM NO.	PRODUCT	SOLD BY
3439 0009	White	CASE OF 1,000
3439 0012	Orange	
3439 0034	Blue	

ITEM NO.	PRODUCT	SOLD BY
3439 04885	White	BOX OF 100
3439 00105	Blue	

Sold by 100 per box.

North[®] Nitri-Knit[™] Insulated Supported Nitrile Coated Gloves



High performance supported nitrile gloves, excellent protection against solvents, caustics and animal fats.

- Complies with USDA and FDA regulations, 21 CFR, for use in food processing.
- Gloves will not swell, sag or weaken from fat absorption.
- Nitrile offers superior mechanical strength and outperforms supported natural rubber, neoprene and vinyl gloves when exposed to solvent, caustics and animal fats.
- True dip coated glove has a permanent bond of nitrile to inner-liner; won't peel apart like glued-in liners.
- Hand portion is treated with a permanent anti-bacterial and anti-mildew agent.
- Insulated versions recommended for temperatures from -10 °F to 300 °F (-23 °C to 149 °C).
- Pebble textured for added grip on wet or dry surfaces.



Pebbled grip finish.

PROTECTS DOWN TO
|-10 °F|

NOTE: Order one size larger in this style of glove.



26" Shoulder Length



12 Inch Short Length

ITEM NO.	SIZE
3476 83371	Size 7
3476 83381	Size 8
3476 83391	Size 9
3476 83401	Size 10
3476 83411	Size 11

SOLD BY
PAIR

26 Inch Shoulder Length

ITEM NO.	SIZE
3476 80421	Size 7
3476 80431	Size 8
3476 80441	Size 9
3476 80451	Size 10
3476 80461	Size 11

SOLD BY
PAIR

Insulated gloves provide added protection for hot or cold applications. Recommended temperatures -10 x °F to 300 °F.

PRICES ARE SUBJECT TO CHANGE • MINIMUMS MAY APPLY • VISIT OUR WEBSITE FOR CURRENT PRICING.

CLOTHING



WorkHorse® 11 Mil Unlined, 13-Inch Straight Cuff Nitrile Gloves

- Chlorinated for ease of donning and doffing.
- Lint-free and reusable.
- Fingertip precision with high dexterity.
- FDA-compliant.



Blue

ITEM NO.	SIZE
E542 10055	Small, 7
E542 10065	Medium, 8
E542 10075	Large, 9
E542 10085	X-Large, 10
E542 10095	2X-Large, 11

SOLD BY
DOZEN PAIR

Green

ITEM NO.	SIZE
E542 09955	Small, 7
E542 09965	Medium, 8
E542 09975	Large, 9
E542 09985	X-Large, 10
E542 09995	2X-Large, 11

SOLD BY
DOZEN PAIR

Economy 13 Mil Latex Rubber Gloves

Latex gloves provide good protection from chemicals, punctures, abrasions and cuts.

- Natural rubber allows excellent dexterity, tensile strength and elasticity.
- 12 inch length for protection against chemical hazards.
- Made from component materials which comply with FDA regulations for food contact 21CFR 177-2600.
- Pinked cuff.

ITEM NO.	SIZE
2201 35775	Size 7
2201 35785	Size 8
2201 35795	Size 9
2201 35805	Size 10
2201 35815	Size 11

SOLD BY
DOZEN PAIR

Ansell



Fish scale grip.

NorthFlex Cold Grip™ Gloves

Foamed PVC palm-coated, lined gloves.

- Recommended for temperatures down to -15 °F (-26 °C).
- Seamless brushed synthetic liner provides superior insulation from the cold.
- Provides excellent wet and dry grip.
- Form fitting design.



ITEM NO.	SIZE
3476 86351	Size 8/Medium
3476 86361	Size 9/Large
3476 86371	Size 10/X-Large
3476 86381	Size 11/2X-Large

SOLD BY
CASE OF 12 PAIR



Reversible Looped Terry Gloves

- Withstands sub-zero temperatures.
- 70% polyester acrylic, 30% blend is shrink-resistant.
- Comfortable, 28-ounce looped terry cloth is seamless and ambidextrous.
- Washable.



ITEM NO.	PRODUCT
3430 56041	One Size Fits All

SOLD BY
PAIR

PRICES ARE SUBJECT TO CHANGE • MINIMUMS MAY APPLY • VISIT OUR WEBSITE FOR CURRENT PRICING.



Nitrile Disposable Gloves

Protection against animal fats, oil-based solvents, petroleum and caustics with strength, puncture-resistance and color-coding compliance.

- Fingertip texture improves grip without sacrificing dexterity.
- 5 mil at the palm. • 9" glove length. • Ambidextrous. • Powder-free

Black

ITEM NO.	SIZE
E542 02755	Small
E542 02765	Medium
E542 02775	Large
E542 02785	X-Large
E542 02795	2X-Large

Orange

ITEM NO.	SIZE
E542 02555	Small
E542 02565	Medium
E542 02575	Large
E542 02585	X-Large
E542 02595	2X-Large

Lime Green

ITEM NO.	SIZE
E542 02655	Small
E542 02665	Medium
E542 02675	Large
E542 02685	X-Large
E542 02695	2X-Large

Green

ITEM NO.	SIZE
E542 04215	Small
E542 04225	Medium
E542 04235	Large
E542 04245	X-Large
E542 04255	2X-Large

Grape

ITEM NO.	SIZE
E542 02455	Small
E542 02465	Medium
E542 02475	Large
E542 02485	X-Large
E542 02495	2X-Large

Blue

ITEM NO.	SIZE
E542 04115	Small
E542 04125	Medium
E542 04135	Large
E542 04145	X-Large
E542 04155	2X-Large



LATEX FREE

THE BENCHMARK IN DISPOSABLE NITRILE GLOVES

SOLD BY
BOX OF 100

450 SERIES

- 3.5 mil at the palm.

Blue

Powder-Free

ITEM NO.	SIZE
E542 04265	Small
E542 04275	Medium
E542 04285	Large
E542 04295	X-Large
E542 04305	2X-Large

SOLD BY
BOX OF 100



PRICES ARE SUBJECT TO CHANGE • MINIMUMS MAY APPLY • VISIT OUR WEBSITE FOR CURRENT PRICING.



7.5-Ounce, Quilt-Lined, Insulated Chore Coat

- Constructed of 100% cotton duck. • Edge stitched corduroy collar with hood snaps.
- Zippered and velcro front closure. • Two-piece button cuff.
- Two chest pockets (velcro closure), double inside cargo pocket and two oversized patch pockets.

ITEM NO.	PRODUCT
3385 14111	Black, Medium
3385 14121	Black, Large
3385 14131	Black, X-Large
3385 14141	Black, 2X-Large
3385 14151	Black, 3X-Large
3385 14161	Black, 4X-Large
3385 01001	Black, Snap-On Hood
3385 34111	Brown, Medium
3385 34121	Brown, Large
3385 34131	Brown, X-Large
3385 34141	Brown, 2X-Large
3385 34151	Brown, 3X-Large
3385 00741	Brown, 4X-Large
3385 34741	Brown Snap-On Hood



SOLD BY EACH



Hooded Thermal Zip-Front Jacket

This is not your average sweatshirt! Cotton/Poly fleece shell with a 5-ounce thermal lining for added warmth.

- Full-length zipper and two-needle stitched main seams for durability.
- Double-layered three-piece hood with drawstring closure.
- Oversized front pockets.
- Elasticized knit waistband.
- Storm knit cuffs.
- Color: navy.

ITEM NO.	SIZE
3385 54811	Small
3385 54821	Medium
3385 54831	Large
3385 54841	X-Large
3385 54851	2X-Large
3385 54861	3X-Large

SOLD BY EACH



Knit Face Mask

- Constructed of Thinsulate™ to trap heat and repel water.
- 100% acrylic. • Color: navy.



ITEM NO.	PRODUCT	SOLD BY
0181 80281	One Size Fits All	EACH

RefrigiWear

- Polartec™ fleece outershell, both waterproof and windproof.
- Wear as balaclava, open hole mask or gaiter.

- Neofleece® moisture-wicking facemask.
- Mouthpiece with breathing holes.
- Color: black.



ITEM NO.	PRODUCT	SOLD BY
0158 10921	One Size Fits All	EACH

SURVO Safety Vest

ANSI/ISEA 107-2020 Class 2.

- Made of orange polyester fabric.
- Two internal pockets; four external pockets, two with flaps, one pocket sewn into four sections to hold pencils.
- 3-inch lime and silver reflective stripes.
- Zipper closure.



ITEM NO.	SIZE
3314 45111	Small
3314 41401	Medium
3314 39691	Large
3314 39681	X-Large
3314 39671	2X-Large
3314 39701	3X-Large
3314 42721	4X-Large

SOLD BY EACH

PRICES ARE SUBJECT TO CHANGE • MINIMUMS MAY APPLY • VISIT OUR WEBSITE FOR CURRENT PRICING.

KOLDWEAR

MADE IN USA

11.5-Ounce Insulated Separates

Nylon duck outer covering 11.5 ounces DuPont HolloFil® insulation.

ITEM NO.	SIZE	SOLD BY
4648 02021	Waist-Length Jacket, Small	EACH
4648 02031	Waist-Length Jacket, Medium	
4648 02041	Waist-Length Jacket, Large	
4648 02051	Waist-Length Jacket, X-Large	
4648 02061	Waist-Length Jacket, 2X-Large	
4648 02071	Waist-Length Jacket, 3X-Large	
4648 02081	Waist-Length Jacket, 4X-Large	EACH
4648 02091	Waist-Length Jacket, 5X-Large	
4648 02101	Waist-Length Jacket, 6X-Large	
4648 03011	Overalls, Small	
4648 03021	Overalls, Medium	
4648 03031	Overalls, Large	
4648 03041	Overalls, X-Large	EACH
4648 03051	Overalls, 2X-Large	
4648 03061	Overalls, 3X-Large	
4648 03071	Overalls, 4X-Large	
4648 03081	Overalls, 5X-Large	
4648 03091	Overalls, 6X-Large	
4648 14141	Optional Hood, One Size Fits All	EACH



High back bib with elasticized waist provides extra warmth and protection to the lower back and kidneys.



Optional lined hood with Velcro® and drawstring closure.

Heavy-duty nylon zippers hold up when machine washed.



KOOLERWEAR

7.4-Ounce, Insulated Cooler Jackets and Vests, Blue with Red Lining

- Insulated with 7.4 ounces of DuPont Dacron 808® fiber fill.
- Two insulated hand warmer pockets. • Machine washable.
- 100% nylon outer shell. • Heavy-duty nylon zipper.



Heavy-duty nylon zipper.

MADE IN USA

Jacket

ITEM NO.	SIZE
4648 50221	Small
4648 50231	Medium
4648 50241	Large
4648 50251	X-Large
4648 50261	2X-Large
4648 28221	3X-Large
4648 28231	4X-Large
4648 28241	5X-Large

SOLD BY EACH

Vest

ITEM NO.	SIZE
4648 50271	Small
4648 50281	Medium
4648 50291	Large
4648 50301	X-Large
4648 50311	2X-Large
4648 55801	3X-Large
4648 55811	4X-Large

SOLD BY EACH

PRICES ARE SUBJECT TO CHANGE • MINIMUMS MAY APPLY • VISIT OUR WEBSITE FOR CURRENT PRICING.

CLOTHING

WorkHorse® 1.5 Mil Disposable Polyethylene Aprons

Economical light-duty alternative.

- Smooth or embossed surface finish.
- Extra-long ties.

2 MIL AND 1 MIL ARE ALSO AVAILABLE. SEE YOUR BUYERS GUIDE OR BUNZLPROCESSOR.COM FOR DETAILS.

Choose from blue, clear, red or white.



ITEM NO.	PRODUCT	SIZE	SOLD BY
E542 17825	Smooth, Red	.28" x 46"	PACK OF 100
E542 05145	Smooth, White	.28" x 46"	
E542 04315	Embossed, Blue	.28" x 46"	
E542 05135	Embossed, White	.28" x 46"	
E542 05105	Smooth, White	.28" x 55"	
E542 05185	Smooth, Blue	.28" x 55"	
E542 17835	Smooth, White	.32" x 52"	PACK OF 50

Vinyl Replacement Aprons

Out performs comparable PVC and vinyl products 3:1.

- VR™ material is softer, flexible and lighter weight.
- Available in translucent blue, opaque yellow or white.
- Choose between die cut and tie.



ITEM NO.	PRODUCT	SIZE/COLOR	SOLD BY
3386 4263	A. 4 Mil, Tie	.35" x 45" Yellow	CASE OF 100
3386 4222	4 Mil, Tie	.35" x 45" White	
3386 3756	6 Mil, Tie	.35" x 45" Blue	
3386 4265	6 Mil, Tie	.35" x 45" Yellow	
3386 4224	6 Mil, Tie	.35" x 45" White	
3386 3757	6 Mil, Tie	.35" x 55" Blue	
3386 3753	B. 6 Mil, Die Cut	.35" x 55" Blue	

Iron Eagle® Polyurethane-Coated Nylon Rainsuit

Designed to withstand the demands of food processing and sanitation.

- 2 mil exterior polyurethane coating on 200 denier nylon oxford fabric is resistant to abrasions, fats, oils, pine tars, gasoline, grease and a variety of other liquids and chemicals.
- Light-weight/flexible material stays soft and comfortable in cold conditions.
- Slick coating sheds liquids with ease, making this suit easy to clean.
- Heavy-duty snaps are guaranteed not to corrode.
- Therm-O-Rad sealed seams are guaranteed for 100% liquid proof protection, and can withstand extensive laundering.
- 5.5 ounce material weight, 10 mil thick.



Full cut shoulder with 90° sleeve to body angle.



Heavy-duty suspenders with crossover back.

TINGLEY

Gold Jacket without Hood (includes Hood Snaps)

ITEM NO.	SIZE	SOLD BY
4059 02071	Small	EACH
4059 02081	Medium	
4059 02091	Large	
4059 02101	X-Large	
4059 02111	2X-Large	
4059 02121	3X-Large	
4059 02131	4X-Large	

Gold Overalls

ITEM NO.	SIZE	SOLD BY
4059 20071	Small	EACH
4059 20081	Medium	
4059 20091	Large	
4059 20101	X-Large	
4059 20111	2X-Large	
4059 20121	3X-Large	
4059 20131	4X-Large	

Yellow overalls also available in 5X and 6X size. Call for more details.

Gold Hood with Snaps

ITEM NO.	SIZE	SOLD BY
4059 2147	One Size	EACH

ADDITIONAL RAINSUITS ARE AVAILABLE. SEE YOUR BUYERS GUIDE OR BUNZLPROCESSOR.COM FOR DETAILS.

PRICES ARE SUBJECT TO CHANGE • MINIMUMS MAY APPLY • VISIT OUR WEBSITE FOR CURRENT PRICING.

WorkHorse® Disposable Embossed Polyethylene Wear

An economic, light-duty alternative in protective wear.



Thumb Loops

1.25 Mil

ITEM NO.	SIZE	COLOR	WRIST	SOLD BY
E542 0519	Small/Tall, 38" x 55"	Blue	Elastic	CASE OF 100
E542 0520	Small/Tall, 38" x 55"	White	Elastic	
E542 0938	Small/Tall, 38" x 55"	Blue	Thumb Loop	
E542 0521	Small/Short, 38" x 46"	Blue	Elastic	



Open Back



Elastic Wrist

1.75 Mil

ITEM NO.	SIZE	COLOR	WRIST	SOLD BY
E542 1050	Medium/Standard, 44" x 50"	Blue	Thumb Loop	CASE OF 4 PACKS OF 25
E542 2255	Medium/Tall, 44" x 55"	Blue	Thumb Loop	
E542 1046	Large/Short, 59" x 45"	White	Thumb Loop	
E542 1155	Large/Tall, 59" x 55"	White	Thumb Loop	

3 Mil

ITEM NO.	SIZE	COLOR	WRIST	SOLD BY
E542 0553	Small/Tall, 38" x 55"	Blue	Thumb Loop	CASE OF 4 PACKS OF 25
E542 0353	Small/Tall, 38" x 55", Full Back	Blue	Thumb Loop	

Vinyl Retail Apron

Excellent moisture-resistance.

- Vinyl remains pliable in temperatures down to -32 °F.
- 31 inches x 39 inches with pencil pocket on bib.
- Metal grommets at stress points; string ties at waist.
- 6 mil thickness.

ITEM NO.	COLOR
4465 91001	White
4465 91011	Red
4465 91021	Green
4465 91031	Blue
4465 91041	Clear
4465 91061	Yellow



Available in 6 colors.

SOLD BY
EACH

WARNING: Some products in this catalog may expose you to chemicals which are known to the State of California to cause cancer or birth defects or other reproductive harm. For more information, visit www.P65Warnings.ca.gov.

15 Mil, Economy PVC Apron

Light-weight, yet durable.

- Adjustable self-material neck band.
- String ties at waist, sewn edges and hem.
- Made of 15-ounce PVC coated nylon fabric.
- 47 inches L x 35 inches W.
- Color: yellow.

ITEM NO.	COLOR
3296 12651	Yellow

SOLD BY
EACH



PRICES ARE SUBJECT TO CHANGE • MINIMUMS MAY APPLY • VISIT OUR WEBSITE FOR CURRENT PRICING.

CLOTHING



Snap-Front Poly/Cotton Butcher Frocks

Roomy bell-shape eliminates the need for slit back.

7-Ounce White, Long Sleeved Frocks

Easy care permanent press 65/35 poly/cotton blend.

- Dome style snaps.
- Available in four styles: 4 outside pockets; 2 inside pockets; 2 outside pockets; or no pockets with 2 side slits to allow access to pant pockets.

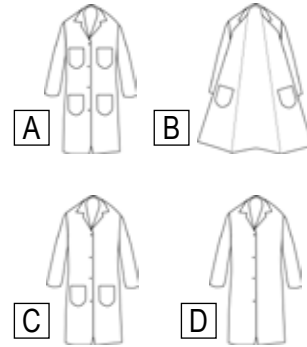

MADE IN USA

A. 4 OUTSIDE POCKETS	B. 2 INSIDE POCKETS	C. 2 OUTSIDE POCKETS	D. NO POCKETS	SIZE	SOLD BY
3092 31341	3092 61051	3092 47051	—	Small	EACH
3092 31351	3092 61061	3092 47061	3092 30601	Medium	
3092 31361	3092 61071	3092 47071	3092 30611	Large	
3092 31371	3092 61081	3092 47081	3092 30621	X-Large	
3092 57841	3092 61091	3092 47091	3092 30631	2X-Large	
3092 30661	3092 61101	3092 47101	3092 30641	3X-Large	
3092 30671	—	3092 47111	3092 30651	4X-Large	

SOME FROCK ORDERS MAY NEED A 5-6 WEEK LEAD TIME. ASK A CSR FOR DETAILS.

ADDITIONAL FROCKS ARE AVAILABLE. SEE YOUR BUYERS GUIDE OR BUNZLPROCESSOR.COM FOR DETAILS.

PRICES ARE SUBJECT TO CHANGE • MINIMUMS MAY APPLY • VISIT OUR WEBSITE FOR CURRENT PRICING.

WorkHorse® Polypro White Lab Coats

Constructed of cool, comfortable and light-weight polypropylene.

- 1.25-ounce lab coat has snaps, long sleeves and no pockets.



ITEM NO.	SIZE	SOLD BY
E542 0301	Large	CASE OF 30
E542 0302	X-Large	
E542 0303	2X-Large	
E542 0304	3X-Large	
E542 0305	4X-Large	
E542 0306	5X-Large	
E542 0307	6X-Large	

ADDITIONAL LAB COATS ARE AVAILABLE. SEE YOUR BUYERS GUIDE OR BUNZLPROCESSOR.COM FOR DETAILS.

Cotton Work Clothing

- Permanent press finish.
- Shirts are white, short sleeved with snap front and chest pocket.
- Pants are white, unhemmed, with 4 pockets and zipper fly.
- 65/35 cotton/poly blend.



SPECIAL ORDER ITEM

Shirts

ITEM NO.	SIZE
4689 0373	Medium
4689 0372	Large
4689 5003	X-Large

SOLD BY EACH

Pants

ITEM NO.	SIZE
4689 0323	30" Waist
4689 0431	32" Waist
4689 2025	34" Waist
4689 2026	36" Waist
4689 2024	38" Waist
4689 2109	40" Waist
4689 2027	42" Waist

SOLD BY EACH

WorkHorse® Color-Coded Latex-Free Bouffant Caps

Color-coding your workplace has never been easier!

- Cool and comfortable to wear.
- Choose from seven colors for easy identification.



SAVE BIG ON SMALL QUANTITIES!
You Won't Find A Better Deal On Bouffant Caps Anywhere!



ITEM NO.	COLOR	SIZE	SOLD BY
E542 04615	White	18"	BAG OF 100
E542 04625	White	21"	
E542 04635	White	24"	
E542 04645	White	28"	



ITEM NO.	COLOR	SIZE	SOLD BY
E542 04655	Green	18"	BAG OF 100
E542 04665	Green	21"	
E542 04675	Green	24"	



ITEM NO.	COLOR	SIZE	SOLD BY
E542 04695	Blue	18"	BAG OF 100
E542 04705	Blue	21"	
E542 04715	Blue	24"	



ITEM NO.	COLOR	SIZE	SOLD BY
E542 04845	Pink	21"	BAG OF 100
E542 04855	Pink	24"	



ITEM NO.	COLOR	SIZE	SOLD BY
E542 04885	Red	21"	BAG OF 100
E542 04895	Red	24"	



ITEM NO.	COLOR	SIZE	SOLD BY
E542 04865	Yellow	21"	BAG OF 100
E542 04875	Yellow	24"	



ITEM NO.	COLOR	SIZE	SOLD BY
E542 03805	Orange	21"	BAG OF 100
E542 04455	Orange	24"	



LATEX FREE

WorkHorse® Poly Hood

A bouffant and beard guard all in one!

- Cool and comfortable to wear.
- 17 inches.



ITEM NO.	COLOR	SOLD BY
E542 0498	White	CASE OF 1,000
E542 0490	Orange	



WorkHorse® Beard Guard

- Light-weight, cloth-like and non-woven.
- Elastic band keeps guard securely in place.
- Lint-free fabric.



LATEX FREE

ITEM NO.	SIZE	COLOR	SOLD BY
E542 04805	18"	White	BAG OF 100
E542 05235	18"	Orange	
ITEM NO.	SIZE	COLOR	SOLD BY
E542 0481	21"	White	CASE OF 500

PRICES ARE SUBJECT TO CHANGE • MINIMUMS MAY APPLY • VISIT OUR WEBSITE FOR CURRENT PRICING.

SAFETY

ERB Americana Safety Cap with 4-Point Slide-Lock Suspension



- Meets ANSI/ISEA Z89.1, TYPE 1 Class C, E and G.
- Moisture-wicking brow pad is removable, washable and replaceable.
- Accessory slots accommodate a variety of eye, face and hearing products.
- 4-point woven nylon suspension. • Accommodates a chin strap.
- Goggle retaining slots on suspension. • Molded from high density polyethylene.



4-Point Slide-Lock Suspension



Easy Quick-Slide sizing adjusts to fit head sizes 6½ - 8.

ITEM NO.	COLOR
3425 00251	Blue
3425 00871	Green
3425 00291	Yellow
3425 97631	Orange
3425 97641	Red
3425 97611	White
3425 00241	Gray
3425 00261	Black

SOLD BY EACH



Optional vented.

ITEM NO.	PRODUCT
3425 92511	White, Vented

SOLD BY EACH



PRICES ARE SUBJECT TO CHANGE • MINIMUMS MAY APPLY • VISIT OUR WEBSITE FOR CURRENT PRICING.

WorkHorse® N95 Molded Respirators*

Available with or without a valve.

- Economical, particulate respirator N95 approved.
- Dual-welded, blue head straps eliminate staples and are visually detectable.
- Shell resists collapsing in heat and humidity.
- Facepiece is naturally contoured without pressure points.



FOOD SAFETY FEATURE – Head strap is heat sealed to mask – no staples that can fall into food.



ITEM NO.	PRODUCT
E542 09315	WorkHorse® N95 Molded w/Valve
E542 09305	WorkHorse® N95 Molded w/o Valve

SOLD BY BOX OF 12 BOX OF 20

WorkHorse® Tapered Disposable Earplugs

NRR-33, highest NRR available in an earplug.

- Tapered shape designed to fit most ear sizes.
- Constructed of expandable foam for a comfortable seal.
- Blue cords and orange earplugs are highly visible.
- Individually poly-bagged.



WorkHorse® Bell-Shaped Disposable Earplugs

- Bell shape follows the natural contours of the ear canal.
- Constructed of expandable foam for a comfortable seal.
- Blue cords and orange earplugs are highly visible.
- Individually poly-bagged.

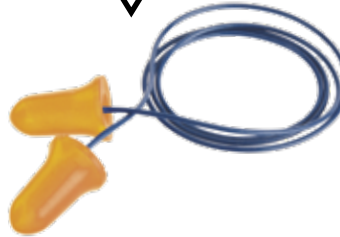

ITEM NO.	PRODUCT	SOLD BY
E542 09455	Tapered Disposable Earplugs	BOX OF 100 PAIR

ITEM NO.	PRODUCT	SOLD BY
E542 09475	Bell-Shaped Disposable Earplugs	BOX OF 100 PAIR

WorkHorse® Reusable Earplugs

- Stem allows for easy insertion into ear.
- Four-flange design conforms to the ear for a comfortable fit.
- Blue cords and orange earplugs are highly visible.
- Individually poly-bagged.



WorkHorse® Reusable Metal Detectable Earplugs

- Both earplugs and cords are metal detectable.
- Stem allows for easy insertion into ear.
- Blue cords and earplugs are highly visible.
- Four-flange design conforms to the ear for a comfortable fit.
- Individually poly-bagged.



ITEM NO.	PRODUCT	SOLD BY
E542 09775	Flanged Reusable Earplugs	BOX OF 100 PAIR

ITEM NO.	PRODUCT	SOLD BY
E542 09765	Reusable, Flanged, Metal Detectable	BOX OF 100 PAIR

WorkHorse® Disposable Metal Detectable Earplugs

- Both earplugs and cords are metal detectable.
- Constructed of expandable foam for a comfortable seal.
- Blue cords and earplugs are highly visible.
- Individually poly-bagged.

ITEM NO.	PRODUCT	SOLD BY
E542 09465	A. Disposable, Tapered, Metal Detectable	BOX OF 100 PAIR
E542 09485	B. Disposable, Bell-Shaped, Metal Detectable	

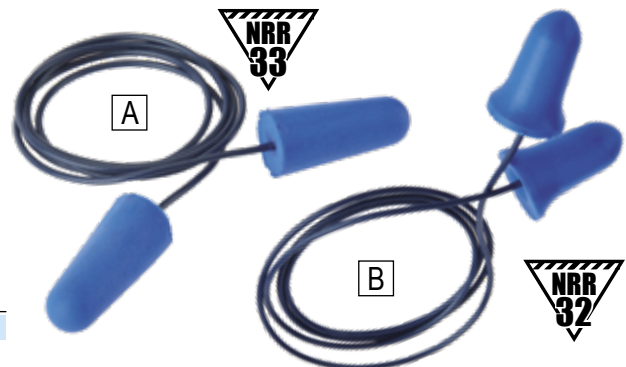

PRICES ARE SUBJECT TO CHANGE • MINIMUMS MAY APPLY • VISIT OUR WEBSITE FOR CURRENT PRICING.

SAFETY



McKesson Medical Antiseptic Isopropyl Alcohol

- Topical first aid antiseptic designed to provide fast, effective first aid for wounds.
- Made without natural rubber latex.
- 70% antiseptic isopropyl alcohol solution.

ITEM NO.	PRODUCT	SOLD BY
3325 00251	Gallon Isopropyl Alcohol	GALLON

ITEM NO.	PRODUCT	SOLD BY
3325 00851	16 oz Isopropyl Alcohol	16 OZ BOTTLE

Metal Detectable Blue Bandages

LATEX FREE

- 1 inch x 3 inch.



ITEM NO.	PRODUCT	SOLD BY
2644 00491	Bandages	BOX OF 50

CLEANING/HYGIENE



Purell® Antimicrobial Fragrance Free Foaming Hand Soap

- One step E2 rated antimicrobial foam soap.
- Removes fats, oils and food soils.
- USDA biobased and certified kosher.
- Fragrance free and dye free formula.
- Hypoallergenic and mild for frequent use.
- Free of phthalates, parabens and triclosan.

ITEM NO.	PRODUCT	SOLD BY
3540 1471	Foaming Hand Soap Refill for ES10 Dispenser	CASE OF 2



Purell Healthy Soap Gentle and Free Foam Refills

Promotes frequent hand-washing and sanitizing!

- Gentle foaming soap.
- Washes away harmful germs and bacteria.
- Infused with moisturizers to prevent skin dryness and irritation.
- Dye- and fragrance-free.
- Hypoallergenic compound.



ITEM NO.	PRODUCT	SOLD BY
3540 0683	Foaming Hand Soap Refill for ES4 Push Dispensers	CASE OF 2
3540 0693	Foaming Hand Soap Refill for ES8 Touch-Free Dispensers	

PRICES ARE SUBJECT TO CHANGE • MINIMUMS MAY APPLY • VISIT OUR WEBSITE FOR CURRENT PRICING.

2-Ply Jumbo Roll Tissue

- 1,000-foot rolls. • Core: 3-3/10 inches.



NOTE: Use with the Twin JRT Dispenser. SEE RIGHT.



ITEM NO.	PRODUCT	SOLD BY
K633 0007	1,000' Jumbo Tissue Roll	CASE OF 12

Twin JRT Dispenser

- Locking mechanism to reduce theft.
- Stub roll feature to reduce waste.
- Back-up roll to reduce run-outs. • Virtually indestructible.
- Translucent cover to monitor tissue supply. • ADA-compliant.
- Holds two 9-inch diameter rolls.



NOTE: Use with the 2-Ply Jumbo Roll Tissue. SEE LEFT.

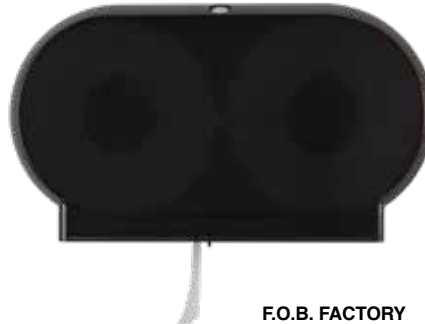

F.O.B. FACTORY

ITEM NO.	PRODUCT
K633 0017	Twin JRT Dispenser

SOLD BY EACH



Metal dual function lock that can become a keyless push button.

Premium Roll Towels

- 1,000-foot rolls.



NOTE: Use with the Towel Dispenser. SEE RIGHT.



ITEM NO.	PRODUCT	SOLD BY
K633 0005	1,000' Premium Roll Towels	CASE OF 6

Brown Roll Towels

- 800-foot rolls.



NOTE: Use with the Towel Dispenser. SEE RIGHT.



ITEM NO.	PRODUCT	SOLD BY
K633 0002	800' Brown Roll Towels	CASE OF 12

Towel Dispenser

- Smooth cut. • Tested for 350,000 pulls.
- Hands-free with back up push paddle.
- Touch only the towel you use.
- Sturdy cover for easier pressure washing.
- ADA-compliant. • No clear plastic lens.
- More water-resistant than other brands.
- Long paper tail and low pull force reduce tabbing.



NOTE: Use with ROLL TOWELS. SEE LEFT.



Holds up to 1,000 feet of toweling to reduce maintenance.



F.O.B. FACTORY

ITEM NO.	PRODUCT
K633 0018	Towel Dispenser

SOLD BY EACH

PRICES ARE SUBJECT TO CHANGE • MINIMUMS MAY APPLY • VISIT OUR WEBSITE FOR CURRENT PRICING.

CLEANING/HYGIENE

Vikan® Ultra Safe Technology (UST) Scrub Brushes

UST provides a new level of hygienic design and bristle arrangement.

- One piece design, no metal staples or resin.
- Easy color-coded visual inspection.
- Easy to clean and dry.

Easy-to-clean
bristle arrangement.

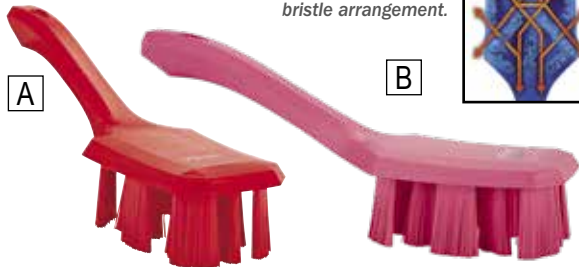

A. Short Handle

ITEM NO.	COLOR
5281 00381	Pink
5281 00281	Green
5281 00391	Blue
5281 00291	Red
5281 00301	White
5281 00311	Yellow
5281 00401	Orange
5281 00411	Purple

SOLD BY
EACH

B. Long Handle

ITEM NO.	COLOR
5281 00431	Pink
5281 00441	Green
5281 00451	Blue
5281 00461	Red
5281 00471	White
5281 00481	Yellow
5281 19671	Orange
5281 00491	Purple

SOLD BY
EACH



Vikan® Total Color Scrub Brushes

Choose from three styles and multiple colors.

- Low water absorption polyester bristles with stainless steel staples.
- Autoclavable at temperatures up to 250 °F/121 °C.
- Hygienic, solid block polypropylene construction.
- Made from FDA-compliant materials.



Scrub Brush, Stiff

2-1/2 inches x 7-1/2 inches

ITEM NO.	COLOR
5281 89051	White
5281 89041	Red
5281 89061	Yellow
5281 89021	Green
5281 89031	Blue
5281 89071	Orange
5281 89081	Purple
5281 89091	Black



SOLD BY
EACH

Short Handle, Stiff

3 inches x 10 inches

ITEM NO.	COLOR
5281 19251	White
5281 19241	Red
5281 19261	Yellow
5281 19221	Green
5281 19231	Blue
5281 19271	Orange
5281 19281	Purple
5281 19291	Black
5281 04011	Pink
5281 04021	Brown
5281 03311	Lime
5281 04031	Gray

SOLD BY
EACH



Long Handle, Stiff

2-3/4 inches x 15-3/4 inches

ITEM NO.	COLOR
5281 18651	White
5281 18641	Red
5281 18661	Yellow
5281 18621	Green
5281 18631	Blue

SOLD BY
EACH

Vikan® Tank Brushes

- Multi-directional bristles are angled and cut to create an oval-shaped head to clean curved surfaces.
- The rounded edges work well to clean down the sides of equipment.



Medium Bristle

5-1/2 inches W x 8 inches H

ITEM NO.	COLOR
5281 03921	Green
5281 02041	Blue
H710 00031	Red
5281 03951	White
5281 03961	Yellow

SOLD BY
EACH

Stiff Bristle

5-1/2 inches W x 8 inches H

ITEM NO.	COLOR
5281 03721	Green
5281 03731	Blue
5281 03741	Red
5281 03751	White
5281 03761	Yellow
5281 03771	Orange
5281 03781	Purple
5281 03791	Black
5281 04221	Brown
5281 04231	Lime
5281 04241	Gray

SOLD BY
EACH



NOTE: Requires a European-thread handle, sold separately. See page 21 for details.

PRICES ARE SUBJECT TO CHANGE • MINIMUMS MAY APPLY • VISIT OUR WEBSITE FOR CURRENT PRICING.

Niagara 6x9-Inch Scouring Pads

Three different strengths for every scouring need.

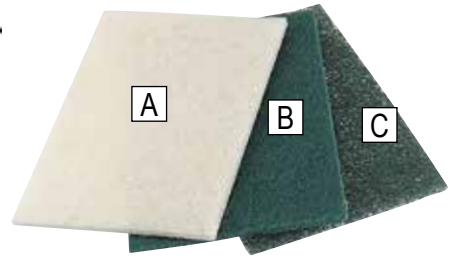

A. Light-Duty Scouring Pad 98N

- Ideal for stainless steel, chrome, copper, porcelain and ceramics. Won't scratch or dull surfaces.

C. Heavy-Duty Scouring Pad 86N

- Replaces scrapers, steel wool and metal sponges for tough jobs.

B. Medium-Duty Scouring Pad 96N

- Cleans pots, pans and kitchen equipment. Ideal for interiors, including walls, railings, floors, stairways and counters.

ITEM NO.	PRODUCT	SOLD BY
6655 9918	A. Light-Duty 98N	CASE OF 20
6655 9696	B. Medium-Duty 96N	CASE OF 60
6655 0186	C. Heavy-Duty 86N	CASE OF 60

Visit BunzlProcessor.com for More Products and Current Pricing.

Scotch-Brite™ Professional Cleaning/Scouring Pads



Heavy-Duty Scouring Pad 86

Made for tough equipment cleaning jobs.

- Replaces scrapers, steel wool and metal sponges.
- Heavy-duty nylon pads cannot rust.

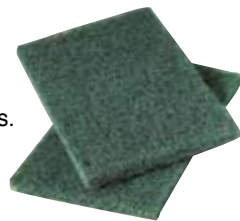

General Purpose Scouring Pad 96

Great for all those common cleaning jobs.

- Performs well on equipment, walls, railings, floors, stairways and counter tops.



ITEM NO.	PRODUCT	SOLD BY	ITEM NO.	PRODUCT	SIZE	SOLD BY
6655 0686	Heavy-Duty Pad 86	BULK PACK OF 60	6655 96005	General Purpose Pad 96	6" x 9"	BOX OF 20

FOR YEARS THE FOOD PROCESSING INDUSTRY HAS TRUSTED ALPET® TO REDUCE THE RISK OF CONTAMINATION

Best Sanitizers Alpet D2 Surface Sanitizer and Disinfectant

- Reliable formula (58% IPA/quat formula).
- Clean, sanitize and disinfect with one product.
- 60 second kill on food contact surfaces, including rubber gloves.
- 10 second kill on non-food contact surfaces, including rubber footwear.
- Kills 99.999% of 9 tested pathogens as a food contact surface sanitizer.
- Highly evaporative and ideal for water sensitive equipment and low moisture environments.
- NSF Listed, EPA Registered, Kosher, Pareve and Halal.
- Now listed on the EPA's list of disinfectants for use against SARS-COV-2.



ITEM NO.	PRODUCT	SOLD BY
0031 9003	Alpet D2 Sanitizer Spray Bottles	CASE OF 12

ITEM NO.	PRODUCT	SOLD BY
0031 2003	Alpet D2 Wipe Canisters	CASE OF 6 CANISTERS

ITEM NO.	PRODUCT	SOLD BY
0031 0018	Alpet D2 Gallon Pail	GALLON PAIL

PRICES ARE SUBJECT TO CHANGE • MINIMUMS MAY APPLY • VISIT OUR WEBSITE FOR CURRENT PRICING.

CLEANING/HYGIENE

Vikan® Extra-Stiff Angle Cut Brooms

Angled design to reach into narrow spaces.

- It is particularly effective for collecting large particles of debris in a moist environment.
- Polypropylene block material with polyester bristles.
- Length: 12 inches.

NOTE: See page 21 for handles, sold separately.



ITEM NO.	COLOR
5281 91451	White
5281 91461	Yellow
5281 01261	Orange
5281 91441	Red
5281 06551	Purple
5281 91431	Blue
5281 91421	Green
5281 06561	Brown
5281 06571	Gray
5281 00351	Black

SOLD BY EACH



Vikan® Color-Coded Dustpans

Color-coded to help organize your workplace.

- Rigid, one-piece, injection-molded polypropylene construction.
- Ergonomic raised-handle design with thumb grip.
- Non-sparking material will not rust or corrode.
- Made from FDA-compliant materials.



ITEM NO.	COLOR	ITEM NO.	COLOR
5281 66051	White	5281 66031	Blue
5281 66061	Yellow	5281 04671	Lime
5281 66071	Orange	5281 66021	Green
5281 66041	Red	H710 00791	Brown
5281 02461	Pink	5281 04681	Gray
5281 66091	Purple	5281 66101	Black

SOLD BY EACH



Vikan® Total Color Deck Brushes

- Hygienic, solid block polypropylene construction with stiff bristles.
- Low water absorption polyester bristles with stainless steel staples.
- Autoclavable at temperatures up to 250 °F/121 °C.
- Made from FDA-compliant materials.
- Block size: 3 inches x 12 inches.
- Bristle length: 1-3/4 inches.



NOTE: See page 21 for handles, sold separately.

ITEM NO.	COLOR
5281 16051	White
5281 0606	Yellow
5281 06071	Orange
5281 0604	Red
5281 02471	Pink
5281 06081	Purple
5281 0603	Blue
5281 04691	Lime
5281 06021	Green
H710 00801	Brown
5281 04701	Gray
5281 16091	Black

SOLD BY EACH



PRICES ARE SUBJECT TO CHANGE • MINIMUMS MAY APPLY • VISIT OUR WEBSITE FOR CURRENT PRICING.



Vikan® One-Piece Ultra Hygiene Squeegees

- One-piece design and co-molded construction eliminates areas that could harbor bacteria.
- Specially blended rubber blade retains its flexibility and durability and is useful on a variety of work surfaces.
- Reinforced polypropylene head.
- Made from FDA-compliant materials.

▶ SEE BELOW

Vikan® Handles Sold Separately.



Scan this QR code with your mobile device to watch a video about Vikan® squeegees.



10 Inch

ITEM NO.	COLOR
5281 07401	Green
5281 12531	Blue
5281 07421	Red
5281 12551	White
5281 07441	Yellow
5281 07451	Orange
5281 12581	Purple
5281 03191	Pink

SOLD BY EACH



10-inch squeegee includes a matching 6.3-inch threaded Vikan® mini handle with a one-piece sealed-design.

16 Inch

ITEM NO.	COLOR
5281 07461	Green
5281 07471	Blue
5281 07481	Red
5281 07491	White
5281 07501	Yellow
5281 03481	Orange
5281 01251	Black
5281 01811	Purple
5281 14011	Pink
5281 04261	Brown
5281 04271	Lime
5281 04341	Gray

SOLD BY EACH

24 Inch

ITEM NO.	COLOR
5281 07681	Green
5281 07571	Blue
5281 07581	Red
5281 07591	White
5281 07601	Yellow
5281 16071	Orange
5281 07621	Black
5281 07611	Purple
5281 02451	Pink
H710 00761	Brown
5281 04281	Lime
H710 00851	Gray

SOLD BY EACH

20 Inch

ITEM NO.	COLOR
5281 07511	Green
5281 07521	Blue
5281 07531	Red
5281 07541	White
5281 07551	Yellow

SOLD BY EACH

28 Inch

ITEM NO.	COLOR
5281 07631	Green
5281 07641	Blue
5281 07651	Red
5281 07661	White
5281 07671	Yellow

SOLD BY EACH

Vikan® Ultra Hygiene Poly Handles

- Made of food-grade polypropylene.
- Safe alternative to fiberglass handles.
- Easy to clean rounded grip handles.
- Hygienic smooth surface, sealed to prevent bacterial growth.
- Larger diameter ergonomic handle shape reduces worker fatigue.



Euro thread.

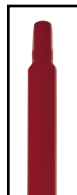

Hygienic design with smooth surface, sealed to prevent bacterial growth.



51 Inch

ITEM NO.	COLOR
5281 86051	White
5281 96061	Yellow
5281 86071	Orange
5281 16041	Red
5281 96011	Pink
5281 96081	Purple
5281 86031	Blue
5281 86021	Green
5281 96091	Black

SOLD BY EACH

59 Inch

ITEM NO.	COLOR
5281 96301	White
5281 96321	Yellow
5281 86271	Orange
5281 16241	Red
5281 96211	Pink
5281 86281	Purple
5281 16231	Blue
5281 03351	Lime
5281 86221	Green
H710 00991	Brown
5281 04291	Gray
5281 96311	Black



PRICES ARE SUBJECT TO CHANGE • MINIMUMS MAY APPLY • VISIT OUR WEBSITE FOR CURRENT PRICING.

CLEANING/HYGIENE

Watersaver Junior Insulated Nozzle

Less than 2/3 the weight of a standard industrial nozzle.



- Variable spray pattern.
- Water saving nozzle, low rate: 5 gpm.
- Constructed of bronze and stainless steel.
- Insulated black rubber cover with yellow directional arrows.
- Instant shut off when trigger is released.
- Rated at 150 psi, up to +180 °F.

3/8-inch NPT inlet.

SWIVEL INCLUDED! Ready to connect to standard male GHT.

VARIABLE SPRAY NOZZLES
Trigger lever controls variable spray pattern.

Wide spray. Narrow spray. Tight stream.

ITEM NO.	PRODUCT	SOLD BY
3566 11511	Nozzle and Swivel, 3/4" GHT	EACH

Insulated Standard-Duty Nozzle

SANI-LAV
COLUMBIA
PRODUCTS

Ideal for industrial use with hot or cold water.

- NOT for high pressure. Rated at 100 psi, up to 180 °F (82 °C).
- Insulated, molded santoprene grip for comfort.
- Instant shut off at nozzle.
- Rust-resistant stainless steel spring.
- Male hose threaded front for attaching accessories.
- Use with city water pressure only. NOT for high pressure.
- Water-saver flow control.
- Plastic handle with brass stem.



OTHER COLORS ARE AVAILABLE.
SEE YOUR BUYERS GUIDE
OR BUNZLPROCESSOR.COM FOR DETAILS.

Remove rubber end piece to expose 3/4" threaded male hose for attaching accessories.

We recommend use with a male GHT x female GHT, swivel adapter, sold separately.

Trigger lock with every adapter.

ITEM NO.	PRODUCT	SOLD BY
3013 30021	Orange Standard-Duty Nozzle	EACH

PRICES ARE SUBJECT TO CHANGE • MINIMUMS MAY APPLY • VISIT OUR WEBSITE FOR CURRENT PRICING.

Guard Air XtraThrust® 75XT Safety Air Gun

- Increased thrust for demanding cleaning tasks.
- Zinc alloy nozzle limits static pressure to less than 30 psi if blocked.
- Includes a cast aluminum body with a hanging hook, an aluminum extension and an ergonomic pistol grip handle.
- Air usage is 54 cubic feet per minute.
- Meets OSHA standards.

Zinc alloy nozzle limits pressure.

Has 0.25 inch FNPT inlet.

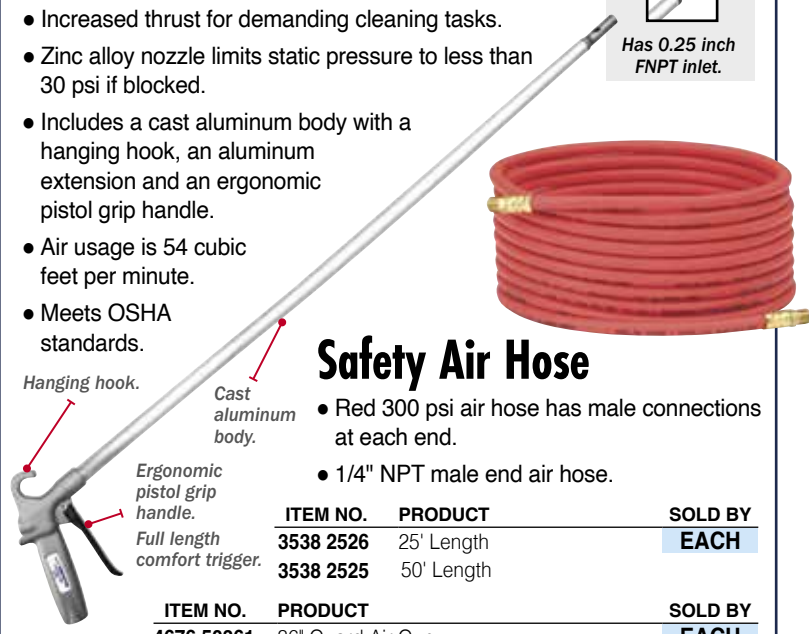

Safety Air Hose

- Red 300 psi air hose has male connections at each end.
- 1/4" NPT male end air hose.

ITEM NO.	PRODUCT	SOLD BY
3538 2526	25' Length	EACH
3538 2525	50' Length	EACH
4676 50361	36" Guard Air Gun	EACH

3/4-Inch ID Single-Ply General Purpose Hose

- Recommended for hot water washdown and light-duty applications.
- Red EPDM cover is resistant to weathering, abrasion and oil.
- Withstands temperatures to 180 °F.



Coupled with female and male garden hose thread.

Medium-weight single-ply reinforced for hot and cold water mixing.

ITEM NO.	PRODUCT	SOLD BY
3538 3025	25' Hose	EACH
3538 3050	50' Hose	EACH
3538 3075	75' Hose	EACH
3538 0105	100' Hose	EACH

Plastic Shovels

- Sturdy injection molded one-piece polypropylene.
- Features a solid shaft and extra thick blade.
- Non-sparking.
- Made from FDA compliant materials.
- Chemical- and corrosion-resistant.
- Small Blade: 11 inches x 14 inches; Overall length: 38 inches; Weight: 2-7/10 pounds.
- Large Blade: 14 inches x 17 inches; Overall length: 42 inches; Weight: 4 pounds.



WHITE	YELLOW	ORANGE	RED	PINK	PURPLE		
ITEM NO.	ITEM NO.	ITEM NO.	ITEM NO.	ITEM NO.	ITEM NO.	PRODUCT	SOLD BY
5281 98101	5281 69801	5281 01081	5281 00081	5281 00271	5281 01091	Small Blade	EACH
5281 98251	5281 69891	5281 98271	5281 69831	5281 01591	5281 69921	Large Blade	

BLUE	LIME	GREEN	BROWN	GRAY	BLACK		
ITEM NO.	ITEM NO.	ITEM NO.	ITEM NO.	ITEM NO.	ITEM NO.	PRODUCT	SOLD BY
5281 98131	5281 04791	5281 98121	5281 04781	5281 04801	5281 01481	Small Blade	EACH
5281 69881	5281 04951	5281 69901	5281 04941	5281 04961	5281 98291	Large Blade	



Colored Plastic Scoops

- Can be sterilized and stacked for storage.
- One-piece molded polypropylene.
- Capacity: Mini: 16 ounce; Small: 32 ounce; Large: 82 ounce.
- Chemical-resistant.
- Made from FDA-compliant materials.



Mini, 16 Ounce Small, 32 Ounce Large, 82 Ounce

ITEM NO.	COLOR	ITEM NO.	COLOR	ITEM NO.	COLOR
5281 30051	White	5281 64001	White	5281 50051	White
5281 30061	Yellow	5281 40061	Yellow	5281 46331	Yellow
5281 30071	Orange	5281 40051	Orange	5281 50071	Orange
5281 30041	Red	5281 64021	Red	5281 46321	Red
5281 03451	Pink	5281 40011	Pink	5281 50011	Pink
5281 30081	Purple	5281 40081	Purple	5281 50081	Purple
5281 30031	Blue	5281 64031	Blue	5281 65011	Blue
5281 04821	Lime	5281 04851	Lime	5281 04511	Lime
5281 30021	Green	5281 64011	Green	5281 46301	Green
5281 04811	Brown	5281 04841	Brown	5281 04881	Brown
5281 04831	Gray	5281 04871	Gray	5281 04491	Gray

SOLD BY EACH

SOLD BY EACH

SOLD BY EACH



Long Handled Paddle Spatulas

Perfect for stirring, mixing and cleaning kettles, vats and large pots.

- Nylon blade sharpens and contours to your specific needs.
- Smooth, easy-to-clean, waterproof construction won't harbor bacteria.
- Threaded, heavy-duty stainless steel handles have plastic grips to provide comfort and heat resistance when used in high temperature or high viscosity applications.
- Available with stainless steel or nylon handles.
- Blade: 4-1/2 inches x 7-1/2 inches.



SOLD BY EACH

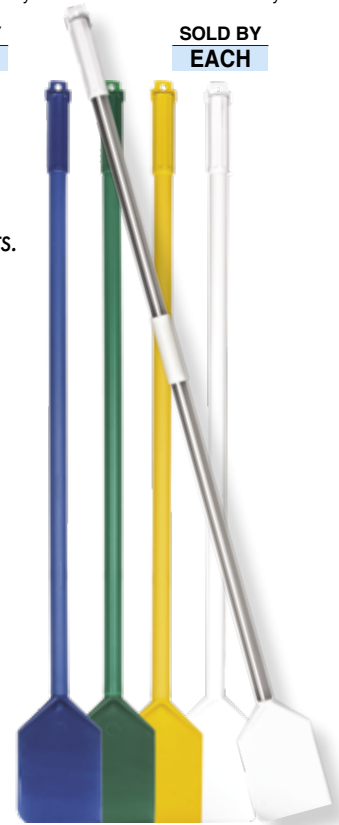

ITEM NO.	PRODUCT
6387 00421	40" Nylon Handled Spatula, White
6387 16761	40" Nylon Handled Spatula, Yellow
6387 17861	40" Nylon Handled Spatula, Green
6387 17871	40" Nylon Handled Spatula, Blue
6387 54001	48" Stainless Steel Handled Spatula, White
6387 61121	4-1/2" x 7-1/2" Nylon Replacement Blade, White

PRICES ARE SUBJECT TO CHANGE • MINIMUMS MAY APPLY • VISIT OUR WEBSITE FOR CURRENT PRICING.

MATERIAL HANDLING

Round Food-Approved Drums and Lids

- Durable construction reinforced with drag skids for maximum longevity.
- Integrated ergonomic handles.
- Unique base handles allow for easy lifting.
- Special features prevent vacuum sealing when nesting.
- Guaranteed to never fade, warp, crack or crush.
- NSF 2 and 21 certified.



10-Gallon Drums and Lids

WHITE	YELLOW	ORANGE	RED	PINK	PURPLE	BLUE	GREEN	GRAY	BLACK	PRODUCT	SOLD BY
ITEM NO.	ITEM NO.	ITEM NO.	ITEM NO.	ITEM NO.	ITEM NO.	ITEM NO.	ITEM NO.	ITEM NO.	ITEM NO.		
6387 24401	6387 24421	6387 24471	6387 24431	6387 24481	6387 24491	6387 24451	6387 24441	6387 24461	6387 24411	Drum	EACH
6387 24511	6387 24531	6387 24581	6387 24541	6387 24591	6387 24611	6387 24561	6387 24551	6387 24571	6387 24521	Lid	

20-Gallon Drums and Lids

WHITE	YELLOW	ORANGE	RED	PINK*	PURPLE	BLUE	GREEN	GRAY	BLACK	PRODUCT	SOLD BY
ITEM NO.	ITEM NO.	ITEM NO.	ITEM NO.	ITEM NO.	ITEM NO.	ITEM NO.	ITEM NO.	ITEM NO.	ITEM NO.		
6387 24631	6387 24651	6387 25251	6387 24661	6387 25261	6387 25271	6387 24681	6387 24671	6387 24691	6387 24641	Drum	EACH
6387 24701	6387 24731	6387 24781	6387 24741	6387 24791	6387 24811	6387 24761	6387 24751	6387 24771	6387 24721	Lid	

32-Gallon Drums and Lids

WHITE	YELLOW	ORANGE	RED	PINK*	PURPLE*	BLUE	GREEN	GRAY	BLACK	PRODUCT	SOLD BY
ITEM NO.	ITEM NO.	ITEM NO.	ITEM NO.	ITEM NO.	ITEM NO.	ITEM NO.	ITEM NO.	ITEM NO.	ITEM NO.		
6387 24831	6387 24851	6387 24901	6387 24861	6387 24911	6387 24921	6387 24881	6387 24871	6387 24891	6387 24841	Drum	EACH
6387 24941	6387 24961	6387 25081	6387 24971	6387 25101	6387 25151	6387 24991	6387 24981	6387 25071	6387 24951	Lid	

44-Gallon Drums and Lids

WHITE	YELLOW	ORANGE	RED	PINK*	PURPLE*	BLUE	GREEN	GRAY	BLACK	PRODUCT	SOLD BY
ITEM NO.	ITEM NO.	ITEM NO.	ITEM NO.	ITEM NO.	ITEM NO.	ITEM NO.	ITEM NO.	ITEM NO.	ITEM NO.		
6387 32701	6387 32711	6387 32791	6387 32721	6387 25331	6387 25341	6387 32741	6387 32731	6387 32761	6387 14761	Drum	EACH
6387 25441	6387 25461	6387 25511	6387 25471	6387 25521	6387 25531	6387 25491	6387 25481	6387 25501	6387 25451	Lid	

55-Gallon Drums and Lids

WHITE	YELLOW	ORANGE*	RED	PINK*	PURPLE*	BLUE	GREEN	GRAY	BLACK	PRODUCT	SOLD BY
ITEM NO.	ITEM NO.	ITEM NO.	ITEM NO.	ITEM NO.	ITEM NO.	ITEM NO.	ITEM NO.	ITEM NO.	ITEM NO.		
6387 05481	6387 09421	6387 25411	6387 09401	6387 25621	6387 05221	6387 09411	6387 55111	6387 55231	6387 15221	Drum	EACH
6387 25641	6387 25661	6387 25751	6387 25671	6387 25721	6387 25731	6387 25701	6387 25691	6387 25711	6387 25651	Lid	

*Certain sizes of orange, pink and purple drums and lids are available by special order. Minimum quantities apply. Ask your CSR for details.

PRICES ARE SUBJECT TO CHANGE • MINIMUMS MAY APPLY • VISIT OUR WEBSITE FOR CURRENT PRICING.

44-Gallon Imprinted Round Drums

Imprinted for clarity and easy identification.

- Each style is Hot Stamp imprinted with black 2-inch lettering.
- All drums are imprinted on 2 sides, in Spanish and English.
- Integrated ergonomic handles. • Unique base handles allow for easy lifting.
- Won't fade, warp, crack or crush. • NSF 2 and 21 certified.



► SEE LEFT For Lids, Sold Separately



Handle design eases lifting and prevents vacuum sealing when stacking.



Durable construction reinforced with drag skids for maximum longevity.



Integrated bag cinches.



44-Gallon Drums

ITEM NO.	COLOR	IMPRINT
3414 01711	White	EDIBLE
3414 01721	Yellow	CONDEMNED
3414 01741	Yellow	INEDIBLE
3414 01791	Yellow	TRASH
3414 01861	Red	CONDEMNED
3414 01681	Red	INEDIBLE
3414 01731	Blue	TRASH
3414 0177	Gray	CONDEMNED
3414 01631	Gray	INEDIBLE
3414 01701	Gray	TRASH

SOLD BY
EACH

Additional sizes are available. See your Buyers Guide or BunzlProcessor.com for details.

THE ONLY HYGIENIC TWIST-ON DOLLY DESIGNED SPECIFICALLY FOR FOOD PROCESSING



Twist-On Hygienic Universal Drum Dolly

- 100% washdown design. • 250-lb. weight capacity.
- Universal fit secures to 20-, 32-, 44-, and 55-gallon drums.
- No sharp corners, edges or hard-to-clean areas where bacteria can reside.
- 5 quiet, non-marking 3-inch swivel casters.

ITEM NO.	PRODUCT	SOLD BY
K633 00251	A. Black Drum Dolly	EACH
K633 00231	B. Blue Drum Dolly	

Zero bacteria harborage points; rounded edges for easy cleaning and drain hole in the middle.



Replacement casters available.

PRICES ARE SUBJECT TO CHANGE • MINIMUMS MAY APPLY • VISIT OUR WEBSITE FOR CURRENT PRICING.

MATERIAL HANDLING

MADE IN USA



ToteAll 2000[®] Molded Poly Boxes

- Max temp: 410 °F/210 °C.
- 4:1 nesting ratio saves space.

50 Pound Capacity

Weighs only 3.8 pounds empty
1.3 cubic feet



90° cross stacking via stacking grooves built into bottom of tote.



ITEM NO.	COLOR
3195 06641	Orange
3195 2013	Tan
3195 46331	Yellow
3195 46351	Green
3195 46341	Blue
3195 00021	Purple
3195 46321	Red
3195 73041	Pink
3195 07071	White
3195 06621	Gray
3195 46361	Black

SOLD BY EACH

OUR TOTEALL 2000[®] POLY BOXES are a first-class product with ribs along the bottom lifting ledge to increase the strength of the ledge when it's used in tote dollies. These reinforcements make our first-class tote a level above our competitors.

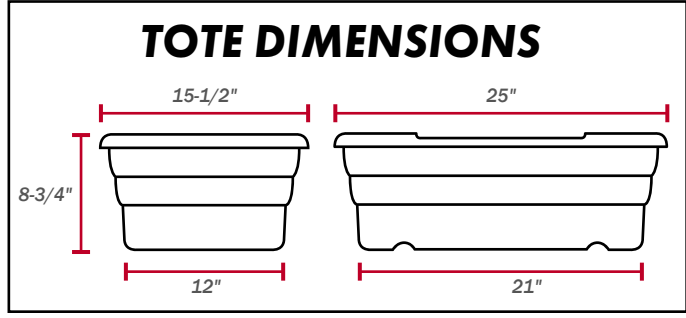

Poly Tote Liners

CALL to request a FREE SAMPLE!

Clean-ups have never been easier! Liners are approved for food contact.

- Liners eliminate the need for cleaning totes — just pull off the used liner and throw away!
- Blue, 1.5 mil polyethylene liners fit all ToteAll 2000[®] totes.

ITEM NO.	PRODUCT	DIMENSIONS	SOLD BY
E179 2215	Blue Tote Liners	22" x 15" x 20"	CASE OF 500

PRICES ARE SUBJECT TO CHANGE • MINIMUMS MAY APPLY • VISIT OUR WEBSITE FOR CURRENT PRICING.

Combo Cap Cover

Attach a combo cap cover over the top of your box to keep contents inside dust and particle free.

- 0.85 mil, clear boxed rolls.

NOTE: We recommend securing cap covers using liner bands, sold separately. SEE BELOW.



Liners come packaged on rolls inside a cardboard box.



Heavy-Duty Drum Liner

- 2.5 mil. • Color: clear.
- 38 inches x 60 inches.

ITEM NO.	PRODUCT
E539 3860	38" x 60"

SOLD BY
ROLL OF 125

ITEM NO.	PRODUCT	DIMENSIONS	SOLD BY
H610 4513	Clear Cap Cover . .	54" x 44" x 36"	ROLL OF 250



Combo Poly Liners

- Increased differential slip allows for easy opening of liners every time.
- For use with cardboard combo bins.
- 2 mil polyethylene.
- Plastic liner keeps food products from coming into contact with cardboard shipping containers.



ITEM NO.	PRODUCT	SOLD BY
E539 0128	54" x 44" x 78"	ROLL OF 25
E539 0115	54" x 44" x 87"	
E539 0129	54" x 44" x 96"	

OTHER SIZES AND GAUGES ARE AVAILABLE. CALL FOR MORE INFORMATION.



Combo Liner Bands

- Use liner bands to secure combo liners and combo cap covers.
- Reusable bands are quickly applied or removed.

ITEM NO.	PRODUCT	SOLD BY
B405 3073	Combo Liner Bands	BAG OF 50

Standard Bags

Sterile sample bags are used to take samples of liquids, semi-solids or solids.

- Puncture-proof tabs are easier and safer to use than any other laboratory sample bag.
- Sterilized by ethylene oxide gas by an independent, ISO-Certified company.
- Documentation of sterility is available upon request.

ITEM NO.	PRODUCT	SIZE	THICKNESS	SOLD BY
4220 10635	24 oz.	6" x 9"4 Mil	CASE OF 500

OTHER SIZES AND THICKNESSES ARE AVAILABLE. SEE YOUR BUYERS GUIDE OR BUNZLPROCESSOR.COM FOR DETAILS.

WARNING: Bags should not be used at temperatures above 180 °F, 82 °C. Bags can be frozen to any temperature, even liquid nitrogen. Careful handling is required after freezing.



Guaranteed Sterile

Whirl-Pak® bags are not autoclavable. Whirl-Pak® bags are sterilized with ethylene oxide gas. Documentation of sterility is available upon request.

"Puncture Proof Tabs"

All Whirl-Pak® bags feature "Puncture Proof Tabs." This patented process extends the tape on the tab past the wire ends eliminating the sharp points which could puncture the bags, scratch a person's hand or puncture gloves.

FDA Compliant

Resins used in the extrusion of film for Whirl-Pak® bags are FDA approved for food contact. Bags are manufactured in accordance with the requirements for manufacturers of single service containers for milk and milk products, as specified by the FDA.

PRICES ARE SUBJECT TO CHANGE • MINIMUMS MAY APPLY • VISIT OUR WEBSITE FOR CURRENT PRICING.



PRICES ARE SUBJECT TO CHANGE • MINIMUMS MAY APPLY • VISIT OUR WEBSITE FOR CURRENT PRICING.



Bunzl Processor Tri-Clamp Buna Gasket

- Engineered for industrial and commercial use.
- Suitable for WFI (water for injection), hot oil, CIP (clean in place) and SIP (steam in place) applications.

Blue Metal Detectable

ITEM NO.	SIZE
E542 14801	1.5"
E542 14811	2"
E542 14821	2.5"
E542 14831	3"
E542 14841	4"

SOLD BY
EACH

Black Standard

ITEM NO.	SIZE
L475 00001	0.5"
L475 00071	1"
L475 00081	1.5"
L475 00091	2"
L475 00101	2.5"
L475 00111	3"
L475 00121	4"

SOLD BY
EACH

Bunzl Processor Tri-Clamp PTFE Gasket

- Engineered for industrial and commercial use.
- Suitable for WFI (water for injection), hot oil, CIP (clean in place) and SIP (steam in place) applications.
- Durable teflon construction.

White Standard Blue Metal Detectable

ITEM NO.	SIZE	ITEM NO.	SIZE
E542 14751	1.5"	E542 14851	1.5"
E542 14761	2"	E542 14861	2"
E542 14771	2.5"	E542 14871	2.5"
E542 14781	3"	E542 14881	3"
E542 14791	4"		

SOLD BY
EACH

SOLD BY
EACH



Bunzl Processor Heavy-Duty Sanitary Clamp, Stainless Steel, Single Post

- Provides a tight, secure fitting to prevent leaks and keep washing equipment running smoothly.
- Ensures proper cleanliness and sanitary conditions.
- Highly-durable stainless steel construction is engineered for industrial use.
- Single post design.

ITEM NO.	SIZE
E542 14681	1.5"
E542 14691	2"
E542 14701	2.5"
E542 14711	3"

SOLD BY
EACH



ALL-WEATHER®
First Choice in Livestock Marking

MADE IN
USA



All-Weather® PaintStik®

- Use on wet or dry animals in holding pen.
- Non-toxic paint is safe for all types of livestock.

ITEM NO.	PRODUCT
1611 10115	Yellow
1611 10125	Pink
1611 10225	Red
1611 10265	Green
1611 10255	Blue
1611 10245	Orange

SOLD BY
BOX OF 12

Orange All-Weather Quik Shot Tail Paint

- Clean to use with no waste.
- Fast drying paint for longer lasting identification on the cows.
- Non-toxic, safe for all livestock.
- V.O.C. compliant.



ALL-WEATHER®
First Choice in Livestock Marking

ITEM NO.	PRODUCT
1611 1114	Tail Paint

SOLD BY
CASE OF 12

Power Actuated Stunners (PAS) TYPE-P Heavy-Duty .25 Caliber, Heavy-Duty Long Bolt



- Ruggedly built for long service life.
- Simple to use, operate and maintain.
- Diverse applications, from smaller to larger sized livestock.
- Renders animal insensible to pain before slaughter.
- Different cartridge strengths available, depending on usage.
- Comfortable, ergonomically, designed handle.
- Includes case and cleaning tools.
- Type-PHDL – Longer length bolt for deeper skull penetration.

ITEM NO.	PRODUCT	JARVIS NO.	SOLD BY
3028 77011	PAS-PHDL 25R, Heavy-Duty Long Bolt .25 Cal	4144132	EACH

JARVIS®

MADE IN
USA

ITEM NO.	DESCRIPTION .25 CALIBER	ROUNDS/PKG	CARTRIDGES	JARVIS NO.	APPLICATIONS
3028 35735	Red Cartridge, 6 Grain	50	.25R	1176026	
3028 35555	Black Cartridge, 4 Grain	1,000	.25S	1176034	

CAUTION: Do not exceed cartridge strength for prescribe usage.

PRICES ARE SUBJECT TO CHANGE • MINIMUMS MAY APPLY • VISIT OUR WEBSITE FOR CURRENT PRICING.

CUTLERY



Sani-Safe® Utility Knife



ITEM NO.	PRODUCT	MFR. NO.	SOLD BY
5816 0145	3-1/2"	S151	EACH

Sani-Safe® Double-Handled Cheese Knife



ITEM NO.	PRODUCT	MFR. NO.	SOLD BY
5816 0051	14"	S11814D	EACH

Sani-Safe® Cheese Knife



DEXTER



ITEM NO.	PRODUCT	MFR. NO.	SOLD BY
5816 03011	12"	S11812	EACH

FURTHER PROCESSING



Special Purity Granulated Food Grade Salt

Manufactured in compliance with all regulations and specifications from FDA, USDA and Food Chemical Codex.

- Meets the standards of the Global Food Safety Initiative (GFSI).
- Kosher-certified for Pareve and Passover.
- Gluten-free.
- Non-GMO.
- No additives.



ITEM NO.	PRODUCT	SOLD BY
A231 0007	Food Grade Salt	50 LB BAG*

*PLEASE NOTE: THIS ITEM CAN ONLY BE PURCHASED IN MULTIPLES OF 49.

FREE GROUND SHIPPING

when you place an order for \$500 or more!

*FREE SHIPPING does NOT include Next Day Air, 2nd Day or 3rd Day Select. Certain items may not qualify. This offer is good only on orders shipped Ground in the 48 contiguous states. Based on dimensional weight, we will determine the most efficient means of shipment. Products may ship by truckline.

PRICES ARE SUBJECT TO CHANGE • MINIMUMS MAY APPLY • VISIT OUR WEBSITE FOR CURRENT PRICING.

PACKING TO FIT EVERY NEED

VFFS CHEESE PACKAGING, CVP BAGS, LIDDING AND MORE



NEED ASSISTANCE?

Our experienced Packaging Specialists are available to help design the packaging in which your product is sealed, or even determine which film or packaging specifications are best for your application.



Chat Online or Call **800-456-5624**



COMMON SIZE AND SHAPE OPTIONS:

3" x 2"	Rectangle
3" x 5"	Rectangle
3" x 6"	Rectangle
3-1/2" x 8"	Rectangle
4" x 2"	Rectangle
4" x 2-1/2"	Rectangle
4" x 3"	Rectangle
4" x 4"	Rectangle
4" x 6"	Rectangle
4" x 8"	Rectangle
4" x 10"	Rectangle
4" x 12"	Rectangle
4" x 14"	Rectangle
2"	Circle
3"	Circle

ORDER CUSTOM LABELS — CALL 800-456-5624

Please have the following information available.

Environment: Freezer Refrigerator Other

Label Use: Packaged Meat Bottles Other

Label Shape: Rectangle Circle Square Oval

Thermal: No Yes Brand/Model _____

Number of Designs: _____ (Minimum 50/Design)

Quantity Per Roll: 1000+ Core: 1 Inch 3 Inch

Questions? _____

Total Quantity: _____

SPECIAL
ORDER
ITEM

PRICES ARE SUBJECT TO CHANGE • MINIMUMS MAY APPLY • VISIT OUR WEBSITE FOR CURRENT PRICING.

PACKAGING



3 Mil Standard Vacuum Pouches

The **FACTS** behind our pouches:

CLARITY
VACUUM POUCHES

- FDA approved for food contact.
- Crystal clear with a glossy finish.
- Contains NO BPA or melamine.
- Contains NO starches or animal by-products.
- Easy to open when filling.
- Made from cast co-extruded film, more flexible and form fitting with an aggressive sealant.



NOTE: These vacuum pouches are only for use in vacuum chamber machines.

Case Pack

ITEM NO.	SIZE	SEAL	QTY/CASE	SOLD BY
1800 6355	3.5 x 9	CE	3,000	CASE
1800 6358	3.5 x 14	CE	3,000	
1800 6360	4 x 8	CE	3,000	
1800 6361	4 x 10	CE	3,000	
1800 2850	4 x 12	CE	3,000	
1800 6463	4.5 x 7	CE	4,000	
1800 6367	4.5 x 10	CE	3,000	
1800 6369	4.5 x 12	CE	3,000	
1800 2851	4.5 x 14	CE	3,000	
1800 6370	4.5 x 18	CE	2,500	
1800 6373	5 x 7	CE	3,500	
1800 6374	5 x 8	CE	3,000	
1800 6375	5 x 9	CE	3,000	
1800 6376	5 x 10	CE	3,000	
1800 6379	5 x 13	CE	3,000	
1800 6382	5.5 x 8	CE	3,000	
1800 6388	6 x 7	TS	4,000	
1800 6389	6 x 8	CE	2,500	
1800 2852	6 x 8	SE	2,500	
1800 2853	6 x 9	SE	2,500	
1800 6391	6 x 10	CE	2,500	
1800 6392	6 x 11	CE	2,500	
1800 6393	6 x 14	CE	2,000	
1800 6394	6 x 18	CE	2,500	
1800 6398	6.5 x 8	CE	2,500	
1800 6399	6.5 x 10	CE	2,500	
1800 2854	7 x 8	SE	3,000	

Case Pack

ITEM NO.	SIZE	SEAL	QTY/CASE	SOLD BY
1800 6404	7 x 9	CE	3,000	CASE
1800 6405	7 x 12	CE	2,500	
1800 1145	7 x 12	SE	2,500	
1800 6406	7 x 14	CE	2,000	
1800 6413	8 x 10	CE	3,000	
1800 6414	8 x 12	CE	2,500	
1800 6415	8 x 14	CE	2,000	
1800 6416	8 x 16	CE	1,250	
1800 6417	8 x 18	CE	1,250	
1800 6419	8 x 23	CE	1,500	
1800 0224	8 x 32	CE	.500	
1800 6424	9 x 18	CE	1,250	
1800 6426	9 x 28	CE	.750	
1800 6428	10 x 15	CE	1,000	
1800 6430	10 x 20	CE	1,000	
1800 6431	10 x 24	CE	1,000	
1800 6436	11 x 20	CE	1,000	
1800 6440	12 x 16	CE	1,250	
1800 6441	12 x 18	CE	1,250	
1800 0261	13 x 18	CS	1,250	
1800 6449	14 x 16	CE	1,000	
1800 6451	14 x 20	CE	1,250	
1800 6452	14 x 24	CE	.500	
1800 6454	14 x 28	CE	.500	
1800 6458	16 x 20	CE	.750	
1800 6459	16 x 26	CE	.500	
1800 6460	16 x 30	CE	.500	

Gassy Cheese Bags, Medium Abuse, High Shrink, Medium Barrier

B2181 and B2183

- Good for gassy cheese such as Swiss, allowing carbon dioxide to escape the packaging while maintaining product freshness.
- Standard gauge. • Color: clear. • Untaped.

NOTE: For SMART PACK seal type, see CASE PACK seal description column.



Case Pack

ITEM NO.	SIZE	SEAL	QTY/CASE	SOLD BY
1800 4756	5 x 9	TS	4,000	CASE
1800 4757	5 x 9	WS	4,000	

Smart Pack

ITEM NO.	SIZE	QTY/BOX	SOLD BY
7584 3528	5 x 9	250	BOX
7584 3531	5 x 9	250	

PRICES ARE SUBJECT TO CHANGE • MINIMUMS MAY APPLY • VISIT OUR WEBSITE FOR CURRENT PRICING.

CLARITY[®]
FLEXIBLE PACKAGING

CRYOVAC[®]

Sealed Air[®]



Series 2000 Shrink Bags — Medium-Abuse, High-Shrink, High Barrier Bags, Untaped

B2170 and B2171

- Good for cheese, smoked and processed meats, retail fresh meats, boneless hams, sausages and processed turkey.
- Standard gauge. • Color: clear.

NOTE: For SMART PACK seal type, see CASE PACK seal description column.



Series 2000 Taped Bags

B2170T and B2171T

- Standard gauge. • Color: clear.
- Seal: CE. • Quantity/Case: 3,500.

Case Pack

ITEM NO.	SIZE	SOLD BY
1800 6464	4.5 x 10	CASE
1800 6467	5.5 x 10	

Case Pack

ITEM NO.	SIZE	SEAL	QTY/CASE	SOLD BY
1800 6355	3.5 x 9	CE	3,000	CASE
1800 6358	3.5 x 14	CE	3,000	
1800 6360	4 x 8	CE	3,000	
1800 6361	4 x 10	CE	3,000	
1800 2850	4 x 12	CE	3,000	
1800 6463	4.5 x 7	CE	4,000	
1800 6367	4.5 x 10	CE	3,000	
1800 6369	4.5 x 12	CE	3,000	
1800 2851	4.5 x 14	CE	3,000	
1800 6370	4.5 x 18	CE	2,500	
1800 6373	5 x 7	CE	3,500	
1800 6374	5 x 8	CE	3,000	
1800 6375	5 x 9	CE	3,000	
1800 6376	5 x 10	CE	3,000	
1800 6379	5 x 13	CE	3,000	
1800 6382	5.5 x 8	CE	3,000	
1800 6388	6 x 7	TS	4,000	
1800 6389	6 x 8	CE	2,500	
1800 2852	6 x 8	SE	2,500	
1800 2853	6 x 9	SE	2,500	
1800 6391	6 x 10	CE	2,500	
1800 6392	6 x 11	CE	2,500	
1800 6393	6 x 14	CE	2,000	
1800 6394	6 x 18	CE	2,500	
1800 6398	6.5 x 8	CE	2,500	
1800 6399	6.5 x 10	CE	2,500	
1800 2854	7 x 8	SE	3,000	
1800 6404	7 x 9	CE	3,000	
1800 6405	7 x 12	CE	2,500	
1800 1145	7 x 12	SE	2,500	
1800 6406	7 x 14	CE	2,000	
1800 6413	8 x 10	CE	3,000	
1800 6414	8 x 12	CE	2,500	
1800 6415	8 x 14	CE	2,000	
1800 6416	8 x 16	CE	1,250	
1800 6417	8 x 18	CE	1,250	
1800 6419	8 x 23	CE	1,500	
1800 0224	8 x 32	CE	500	
1800 6424	9 x 18	CE	1,250	
1800 6426	9 x 28	CE	750	
1800 6428	10 x 15	CE	1,000	
1800 6430	10 x 20	CE	1,000	
1800 6431	10 x 24	CE	1,000	
1800 6436	11 x 20	CE	1,000	
1800 6440	12 x 16	CE	1,250	
1800 6441	12 x 18	CE	1,250	
1800 0261	13 x 18	CS	1,250	
1800 6449	14 x 16	CE	1,000	
1800 6451	14 x 20	CE	1,250	
1800 6452	14 x 24	CE	500	
1800 6454	14 x 28	CE	500	
1800 6458	16 x 20	CE	750	
1800 6459	16 x 26	CE	500	
1800 6460	16 x 30	CE	500	

Smart Pack

ITEM NO.	SIZE	QTY/BOX	SOLD BY
7584 3301	3.5 x 9	250	BOX
7584 3304	3.5 x 14	250	
7584 3306	4 x 8	250	
7584 3307	4 x 10	250	
7584 3492	4 x 12	250	
7584 1268	4.5 x 7	250	
7584 3313	4.5 x 10	250	
7584 1267	4.5 x 12	250	
7584 3493	4.5 x 14	250	
7584 3316	4.5 x 18	250	
7584 3319	5 x 7	250	
7584 3320	5 x 8	250	
7584 3321	5 x 9	250	
7584 3322	5 x 10	250	
7584 3325	5 x 13	250	
7584 3328	5.5 x 8	250	
7584 3334	6 x 7	250	
7584 3335	6 x 8	250	
7584 3495	6 x 8	250	
7584 3494	6 x 9	250	
7584 3337	6 x 10	250	
7584 3338	6 x 11	250	
7584 3339	6 x 14	250	
7584 3340	6 x 18	250	
7584 3344	6.5 x 8	250	
7584 3345	6.5 x 10	250	
7584 3496	7 x 8	250	
7584 3349	7 x 9	250	
7584 3350	7 x 12	250	
7584 3554	7 x 12	250	
7584 3351	7 x 14	250	
7584 3358	8 x 10	250	
7584 3359	8 x 12	250	
7584 3360	8 x 14	250	
7584 3361	8 x 16	250	
7584 3362	8 x 18	250	
7584 3363	8 x 23	250	
7584 1266	8 x 32	250	
7584 3368	9 x 18	250	
7584 3370	9 x 28	250	
7584 3372	10 x 15	250	
7584 3374	10 x 20	250	
7584 3375	10 x 24	250	
7584 3380	11 x 20	250	
7584 3384	12 x 16	250	
7584 3385	12 x 18	250	
7584 1265	13 x 18	250	
7584 3393	14 x 16	250	
7584 3395	14 x 20	250	
7584 3396	14 x 24	250	
7584 3398	14 x 28	250	
7584 3402	16 x 20	250	
7584 3403	16 x 26	250	
7584 3404	16 x 30	250	

PRICES ARE SUBJECT TO CHANGE • MINIMUMS MAY APPLY • VISIT OUR WEBSITE FOR CURRENT PRICING.



Food Grade Lubricants

CRC NSF registered H1 products meet the highest standards of safety and performance. CRC's line of food grade products deliver exceptional lubrication and protection in food processing and manufacturing environments.



All CRC Products Are Food Grade

Registered as H1 with NSF

QR Code on Each Container Provides Allergen Certificate, NSF Registration Letters and MSDS for Each Product



CRC Dielectric Grease

- Non-curing silicone compound.
- Seals and insulates electrical parts.
- Waterproofs connections and components.
- Prevents arcing from moisture and contaminants.
- Improves performance in harsh conditions.
- NSF H1 registered for food contact.
- Select-a-Bead nozzle for precise application.

ITEM NO.	PRODUCT	SOLD BY
1210 00331	10 oz Dielectric Grease	EACH

CRC Sta-Lube FG Anti-Seize and Lubricating Compound



- This aluminum complex based anti-seize protects metal parts from seizure, galling, rust, corrosion and heat freeze by tenaciously adhering to metal surfaces.
- High temperature resistance up to 1800°F.
- Non-staining, odorless and tasteless.
- Contains no metals.
- Brush top bottle.

ITEM NO.	PRODUCT	SOLD BY
1210 00261	16 oz Lubricating Compound	EACH



CRC Contact Cleaner

- Non-flammable.
- Plastics safe.
- Evaporates quickly, leaves no residue.
- Non-chlorinated, non-staining and non-corrosive.
- Contains No VOCs.

ITEM NO.	PRODUCT	SOLD BY
1210 00511	14 oz Contact Cleaner	EACH

CRC Sta-Lube Multi Purpose Food Grade Grease

- Recommended for high temperature applications.
- White color, smooth buttery texture.
- Resists rust and corrosion and will not pound out of bearings and bushings during shock loads.



ITEM NO.	PRODUCT	SOLD BY
1210 00171	35 lb Multi Purpose Grease	EACH

CRC Food Grade Dielectric Grease

- Provides an exceptional lubricant for fasteners used to support temporary electrical work.
- Excellent for lubricating and sealing.
- NSF H1 registered for incidental food contact.
- Temperature resistant – maintains performance year round.
- Pressurized tube with Select-a-Bead® Nozzle allows for precise application of product.



ITEM NO.	PRODUCT	SOLD BY
1210 00231	3.3 oz Dielectric Grease	EACH

Visit BunzlProcessor.com for More CRC Products and Current Pricing.

PRICES ARE SUBJECT TO CHANGE • MINIMUMS MAY APPLY • VISIT OUR WEBSITE FOR CURRENT PRICING.

Revolutionizing Reliable Battery Power for the Food Processing Industry

Ultra Pro™ Alkaline Batteries

The ultimate in savings with packaging specifically designed for today's industrial customer.

- Shrink-wrapped packs are easy to snap open.
- Ideal for contractors and end users on a production line.



ITEM NO.	PRODUCT	SOLD BY
7784 00045	Ultra Pro™ AAA	PACK OF 8
7784 00035	Ultra Pro™ AA	

ITEM NO.	PRODUCT	SOLD BY
7784 01361	Ultra Pro™ AAA	PACK OF 24
7784 01271	Ultra Pro™ AA	

ITEM NO.	PRODUCT	SOLD BY
7784 00015	Ultra Pro™ C	PACK OF 6
7784 00025	Ultra Pro™ D	
7784 00075	Ultra Pro™ 9V	

ITEM NO.	PRODUCT	SOLD BY
7784 01815	Ultra Pro™ C	PACK OF 12
7784 01825	Ultra Pro™ D	



THERMOMETER

Waterproof Instant Read Digital Thermometer with Protective Pocket Clip Case

- Waterproof design makes thermometer ideal for both wet and dry environments.
- Easy to clean exterior provides minimal maintenance downtime.
- Easily recalibratable to ensure accurate readings at all times.
- Includes Safe-T-Guard sleeve to prevent bacteria and mold growth.
- Includes LR44 battery that is ready to use.

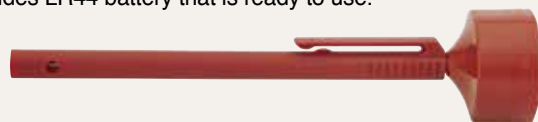

Protective Pocket Clip Case

ITEM NO.	PRODUCT	TEMP. RANGE	SOLD BY
3542 98421	Waterproof Therm	-40° to +450 °F	EACH

Stainless Steel Bi-Metal Pocket Dial Thermometers



- 1-inch dial thermometer comes with plastic sheath with clip.
- External easy recalibration.
- Accuracy ±1 °F at calibration point.
- All stainless steel external parts.
- Shatter-resistant plastic lens.
- NSF approved.



ITEM NO.	PRODUCT	TEMP. RANGE	SOLD BY
3542 9621	A. 1" Dial Diameter, 5" Skewer	-40° to +160 °F	EACH
3327 1225	B. 2" Dial Diameter, 8" Skewer	0° to +220°F	



1-inch dial includes probe sheath and pocket clip. FREE Calibration tool included on sheath.

PRICES ARE SUBJECT TO CHANGE • MINIMUMS MAY APPLY • VISIT OUR WEBSITE FOR CURRENT PRICING.

SCALES



Stainless Steel Washdown Scales

Washdown when powered by batteries.

- Removable 9-inch x 7-1/2-inch platform for easy washdown.
- Digital LCD readout displays 1-inch numerals and also features auto shutoff and push button tare, zero reset and low battery indicator.
- Class III rated. • Scales weigh in pound/decimal pound and gram/kilogram.
- Shipping Weight: 8 pounds. • Six D batteries required, sold separately.



ITEM NO.	MODEL	POUNDS (lb) CAPACITY/ RESOLUTION	GRAMS (g) CAPACITY/ RESOLUTION	SOLD BY
3416 1001	SK-1000WP	2.2 lb/0.001 lb	1,000 g/0.5 g	EACH
3416 2002	SK-2000WP	4.4 lb/0.002 lb	2,000 g/1 g	
3416 5002	SK-5000WP	11 lb/0.005 lb	5,000 g/2 g	
3416 0011	SK-10KWP	22 lb/0.01 lb	10 kg/0.005 kg	
3416 0021	SK-20KWP	44 lb/0.02 lb	20 kg/0.01 kg	
3416 00041	Optional Adapter			

-LEGAL FOR TRADE-

NOTE: AC adapter sold separately.

Stainless Steel Washdown Bench Scale

Stainless steel washdown construction is dust- and water-resistant.

- IP65 rated washdown construction with stainless steel pan.
- Resolution can be changed automatically for three capacity levels.
- Triple weighing range function.
- Set your own high and low weight targets.
- LED comparator traffic lights.
- Accumulation and counting functions.
- Tilttable display with 10-digit keypad and memory storage.
- Change the weighing units and mode with the press of a button.
- A/C main (100 to 240V).



-LEGAL FOR TRADE-

LCD display with white backlight.



LED comparator lights.

Alphanumeric keypad.

F.O.B. FACTORY

ITEM NO.	MODEL	CAPACITY	RESOLUTION	PLATFORM	SHIP WT.	SOLD BY
3416 1060	HV-60KC-WP	150 lb.	0.05 lb	13" x 16-7/10"	26 lb	EACH
3416 1200	HV-200KC-WP	500 lb.	0.2 lb	15-2/5" x 20-9/10"	42 lb	



PRICES ARE SUBJECT TO CHANGE • MINIMUMS MAY APPLY • VISIT OUR WEBSITE FOR CURRENT PRICING.

OFFICE AND SHIPPING

Stretch Film and Hand Dispenser

- Premium grade film has unparalleled load-holding force and is highly puncture-and tear-resistant.
- Hand dispenser accommodates film rolls between 12 and 20 inches.



Hand Dispenser

ITEM NO.	PRODUCT	SOLD BY
3105 0800	Hand Dispenser	EACH

Machine Film

ITEM NO.	PRODUCT	SOLD BY
6431 9049	49-Gauge, Machine, 20" x 9,000'	ROLL
6431 0045	70-Gauge, Cast Machine Film, 20" x 6,500'	
6431 5080	80-Gauge, Cast Machine Film, 20" x 5,000'	

Hand Film

ITEM NO.	PRODUCT	SOLD BY
6431 1650	39-Gauge, Ecostretch, 16" x 1,500'	CASE OF 4 ROLLS
6431 1571	70-Gauge, Blown Hand Film, 15" x 1,500'	
6431 00745	70-Gauge, Blown Hand Film, 18" x 1,500'	
6431 0001	80-Gauge, Blown Hand Film, 18" x 1,500'	

Metal Detectable

All Stainless Steel Retractable Ballpoint Pen

The heavy-duty stainless-steel barrel with a knurled grip ensures superior writing stability. Rugged and sturdy, this ballpoint pen can take a beating and is ideal for factory environment.

- Durable stainless steel is metal detectable – tip, barrel, clip.
- Secure knurled grip.
- Silent retractable plunger.



All Stainless Steel Black Refill

The steel ballpoint uses smooth, easy-glide ink for a more controlled writing experience.

- Premium all-metal refill is easily metal detectable making it ideal for factory settings.
- Effortless refill process makes it great for everyday use.

ITEM NO.	PRODUCT	SOLD BY	ITEM NO.	PRODUCT	SOLD BY
M268 00011	Retractable Pen	EACH	M268 00021	All Metal Stainless Steel Refill, 0.8mm Black	EACH

DYKEM® SAFE-MARK NSF Certified General Purpose Markers

- General purpose, quick-drying permanent ink marker.
- Marks withstand temperatures spanning -20 °F to 475 °F.
- “Locked nib” prevents tip from falling out and into processing operations.
- Valve action mechanism prevents barrel ink from drying when cap is left off.
- Ideal for any surface: metal, glass, plastic, cardboard, rubber, shrink film, stretch wrap, etc.



ITEM NO.	PRODUCT	SOLD BY
3112 09071	Black Marker	EACH

Chrome Plier Stapler

- Easy squeeze lever action. • Staples up to 20 sheets.
- All metal construction for superior performance and durability.
- No-Jam™ technology eliminates frustrating staple jams.
- Fast top-load design for easy reloading.
- Full strip stapler – 210 staple capacity.



ITEM NO.	PRODUCT
2305 4604	Chrome Plier Stapler

SOLD BY
EACH

Stainless Steel Staples

- 1/8 inch staples.



ITEM NO.	PRODUCT
2305 5504	Stainless Steel 1/4" Staples

SOLD BY
BOX OF 5,000

Domtar Industries Plain White Copy Paper

- 8.5 inches x 11 inches plain white. • 500 sheets per pack.
- 92 Bright 20# paper.
- For use with laser and ink jet printers, plain paper fax machines and copiers.



ITEM NO.	PRODUCT
7282 0012	92 Bright 20# Copy Paper

SOLD BY
CASE OF 10 PACKS

PRICES ARE SUBJECT TO CHANGE • MINIMUMS MAY APPLY • VISIT OUR WEBSITE FOR CURRENT PRICING.



Scotch® High Tack Box Sealing Tape 311+ **3M**

- High performance, high tack industrial packaging tape designed for cold and damp temperatures.
- Great for box sealing, splicing, recoupage and demanding packaging applications.
- Excellent performance over broad temperature ranges, even below freezing.
- Quick and easy application by hand, manual dispensers or 3M-Matic™ Case Sealers.
- Adheres to highly recycled corrugated boxes. • Available in 48 mm and 72 mm widths.
- Core diameter: 3 inches.

NOTE: Can be applied at cold temperatures of 20-50 °F and performs at temperatures below 32 °F.

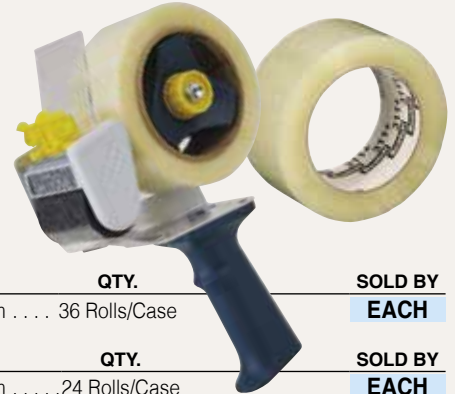

Machine Size Rolls

ITEM NO.	PRODUCT	QTY.	SOLD BY
6655 3830	48 mm x 914 m	6 Rolls/Case	CASE
6655 3831	48 mm x 1,500 m	6 Rolls/Case	
6655 3638	72 mm x 914 m	4 Rolls/Case	
6655 4826	72 mm x 1,500 m	4 Rolls/Case	

Hand Size Rolls

ITEM NO.	PRODUCT	QTY.	SOLD BY
6655 38281	48 mm x 100 m	36 Rolls/Case	EACH
6655 38781	72 mm x 100 m	24 Rolls/Case	EACH
H350 00021	Tape Dispenser		EACH

Bunzl Processor 3 Mil Teflon Tape with Silicone Adhesive without Liner

Engineered for the tough demands of commercial use.

- Ensures a tight seal across a variety of applications.
- Teflon construction with silicone adhesive.



Tape wo/Liner

Silicone Tape wo/Liner

ITEM NO.	PRODUCT	SOLD BY
M553 00361	1/2" Roll	36 YD ROLL
MSS3 00401	3/4" Roll	
M553 00231	1" Roll	
M553 00411	1-1/2" Roll	
M553 00371	2" Roll	
M553 00321	3" Roll	
M553 00331	4" Roll	

Bunzl Processor 3 Mil SS Silicone Adhesive with Liner

- Ideal for adhering and sealing in commercial and industrial applications.
- Silicone adhesive.



Tape Liner

Silicone Tape w/Liner

ITEM NO.	PRODUCT	SOLD BY
M553 00281	1/4" Roll	36 YD ROLL
M553 00271	3/8" Roll	
M553 00261	1/2" Roll	
MS53 01161	9/16" Roll	
M553 00351	3/4" Roll	
M553 00291	1" Roll	
M553 00521	1-1/8" Roll	
MS53 00311	1-1/2" Roll	
M553 00341	2" Roll	
M553 00381	3" Roll	

OTHER SIZES AND THICKNESSES ARE AVAILABLE.

TydenBrooks FlexSecure Cable Seals

- Tamper-evident design ensures added safety, protecting your cargo.
- Non-performed steel cable unravels when cut.
- Tensile strength: 2,400 lbs. • 12 inches black.
- High-security-rated and CTPAT and PIP compliant.
- Patent-pending locking mechanism inside an anodized aluminum housing, providing superior security.

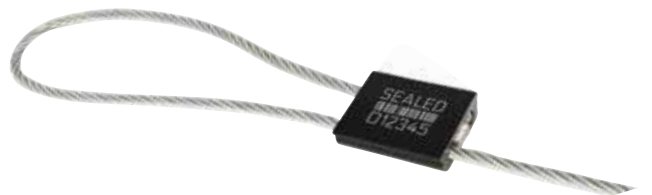

ITEM NO.	PRODUCT	SOLD BY
6499 2035	FlexSecure Cable Seals	CASE OF 200

PRICES ARE SUBJECT TO CHANGE • MINIMUMS MAY APPLY • VISIT OUR WEBSITE FOR CURRENT PRICING.

Nordic Ice® Temperature Control Packs

Packs are reusable and non-toxic, stay frozen longer than ice. Economical to use.

- When packing, place gel pack on top of product. Leave as little dead space as possible.
- Biodegradable. • Freezes solid.

NOTE: Sold by case only.

ITEM NO.	PRODUCT	SOLD BY
C928 1016	16 oz., 6-1/2" x 5-1/2" x 1"	CASE OF 36
ITEM NO.	PRODUCT	SOLD BY
C928 1024	24 oz., 7-1/2" x 5-1/2" x 1-1/4"	CASE OF 24
ITEM NO.	PRODUCT	SOLD BY
C928 1048	48 oz., 10-1/2" x 7-1/2" x 1-1/4"	CASE OF 12



Plastilite Integritemp TK6 Series EPS Foam Cooler with Shipping Box

- EPS foam is the best economical choice when you need to send temperature sensitive products.
- Includes shipping box.
- Interior Dimensions: 7.75 inches x 5.875 inches x 6 inches.
- Exterior Dimensions: 11.25 inches x 9.25 inches x 9.625 inches.
- Wall Thickness: 1.5 inches. • 4.7 quarts. • Recyclable.

ITEM NO.	PRODUCT	SOLD BY
4768 00191	TK6 Series EPS Foam Cooler with Shipping Box	EACH



Plastilite Integritemp PC850 Series EPS Foam Cooler with Shipping Box

- The most economical choice when you need to send temperature sensitive products.
- An economical and ecologically solution to distribute temperature-sensitive products in a cost-effective manner.
- Interior Dimensions: 19.625 inches x 12.625 inches x 8.5 inches.
- Exterior Dimensions: 23.625 inches x 16.625 inches x 12.375 inches.
- Wall Thickness: 1.5 inches. • 36.5 quarts. • Includes shipping box. • Recyclable.

ITEM NO.	PRODUCT	SOLD BY
4768 50231	PC850 Series EPS Foam Cooler with Shipping Box	EACH



H.B. Fuller Hot Melt Adhesive Pellets, Swift®therm 2H882

- Versatile general purpose.
- 350°F application temperature.
- Fast set speed.

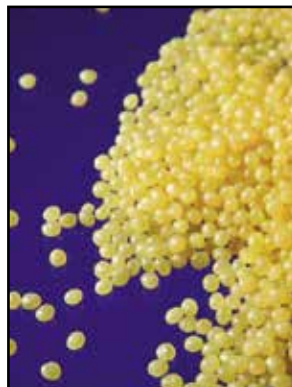

ITEM NO.	PRODUCT	SOLD BY
H336 0020	H.B. Fuller Hot Melt Adhesive Pellets	CASE OF 38 LBS

H.B. Fuller Hot Melt Adhesive Pillows, Clean Melt PHC8250

- Char-Free technology.
- Gentle on equipment.
- Odor-Free and light color.
- Clean cutoff and precise application.
- Wide temperature performance range (325°F - 360°F).



ITEM NO.	PRODUCT	SOLD BY
H336 0015	H.B. Fuller Hot Melt Adhesive Pillows	CASE OF 31 LBS

PRICES ARE SUBJECT TO CHANGE • MINIMUMS MAY APPLY • VISIT OUR WEBSITE FOR CURRENT PRICING.



CHECK OUT THE DAIRY SECTOR ON OUR WEBSITE

BunzlProcessor.com

STAY CONNECTED WITH US:



Need Help?
Chat With Us
Online!



Call 800-456-5624

TWO WAYS TO ORDER!

BunzlProcessor.com

30,000+
FOOD PROCESSING
PRODUCTS
AT YOUR FINGERTIPS

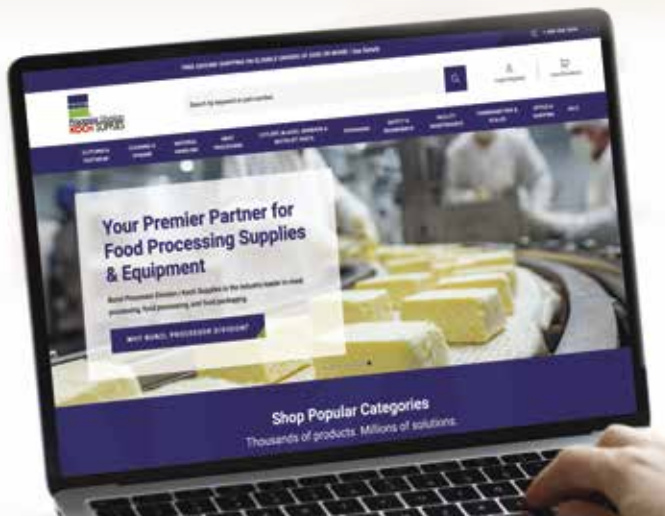

DISTRIBUTION CENTERS

ARKANSAS ■ SPRINGDALE

CALIFORNIA ■ FRESNO

COLORADO ■ DENVER

GEORGIA ■ ATLANTA

IOWA ■ ELDRIDGE

KANSAS ■ LIBERAL

MINNESOTA ■ AUSTIN

MISSOURI ■ KANSAS CITY

NORTH CAROLINA ■ LUMBERTON

NEBRASKA ■ OMAHA

OHIO ■ FAIRFIELD

PENNSYLVANIA ■ YORK

TEXAS ■ DALLAS

WASHINGTON ■ SPOKANE